

2SA966

Rev.E Mar.-2016

描述 / Descriptions

TO-92LM 塑封封装 PNP 半导体三极管。Silicon PNP transistor in a TO-92LM Plastic Package.

特征 / Features

与 2SC2236 互补,可得到 3W 输出。

Complementary to 2SC2236 and 3 Watts output applications.

用途 / Applications

用于音频功率放大。

AF power amplifier applications.

内部等效电路 / Equivalent Circuit

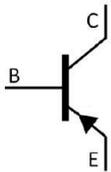

引脚排列 / Pinning



PIN 1 : Base PIN 2 : Collector PIN 3 : Emitter

放大及印章代码 / h_{FE} Classifications & Marking

h_{FE} Classifications Symbol	O	Y
h_{FE} Range	100~200	160~320

极限参数 / Absolute Maximum Ratings(Ta=25°C)

参数 Parameter	符号 Symbol	数值 Rating	单位 Unit
Collector to Base Voltage	V_{CBO}	-30	V
Collector to Emitter Voltage	V_{CEO}	-30	V
Emitter to Base Voltage	V_{EBO}	-5.0	V
Collector Current - Continuous	I_C	-1.5	A
Emitter Current - Continuous	I_E	1.5	A
Collector Power Dissipation	P_C	900	mW
Junction Temperature	T_j	150	°C
Storage Temperature Range	T_{stg}	-55~150	°C

电性能参数 / Electrical Characteristics(Ta=25°C)

参数 Parameter	符号 Symbol	测试条件 Test Conditions	最小值 Min	典型值 Typ	最大值 Max	单位 Unit
Collector to Emitter Breakdown Voltage	V_{CEO}	$I_C=-10mA$ $I_B=0$	-30			V
Emitter to Base Breakdown Voltage	V_{EBO}	$I_E=-1.0mA$ $I_C=0$	-5.0			V
Collector Cut-Off Current	I_{CBO}	$V_{CB}=-30V$ $I_E=0$			-0.1	μA
Emitter Cut-Off Current	I_{EBO}	$V_{EB}=-5.0V$ $I_C=0$			-0.1	μA
DC Current Gain	h_{FE}	$V_{CE}=-2.0V$ $I_C=-500mA$	100		320	
Collector to Emitter Saturation Voltage	$V_{CE(sat)}$	$I_C=-1.5A$ $I_B=-30mA$			-2.0	V
Base to Emitter Voltage	V_{BE}	$V_{CE}=-2.0V$ $I_C=-500mA$			-1.0	V
Transition Frequency	f_T	$V_{CE}=-2.0V$ $I_C=-500mA$		120		MHz
Collector output capacitance	C_{ob}	$V_{CB}=-10V$ $I_E=0$ $f=1.0MHz$			30	pF

电参数曲线图 / Electrical Characteristic Curve

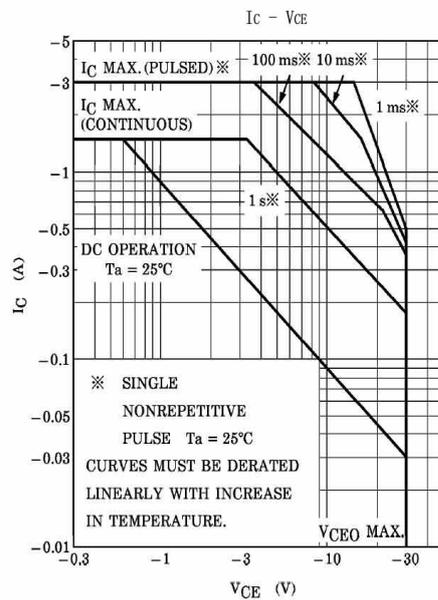
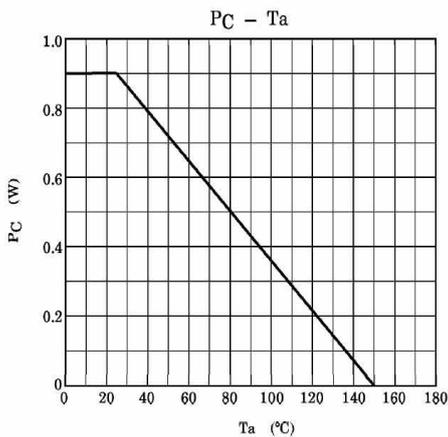
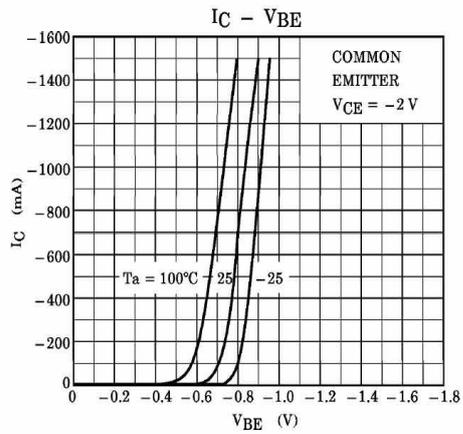
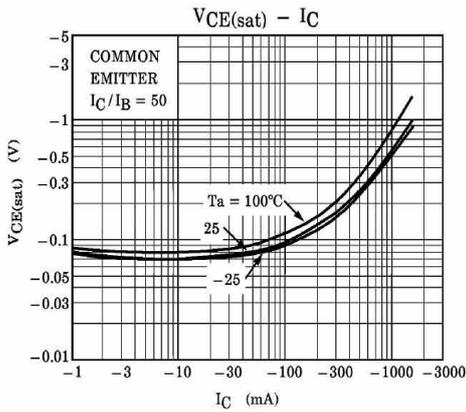
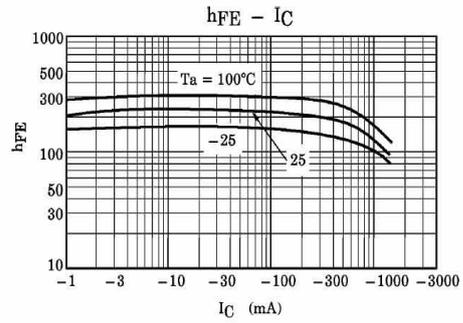
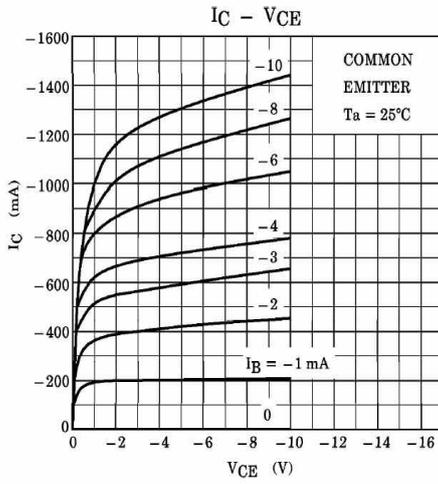

外形尺寸图 / Package Dimensions

T0-92LM

Unit: mm

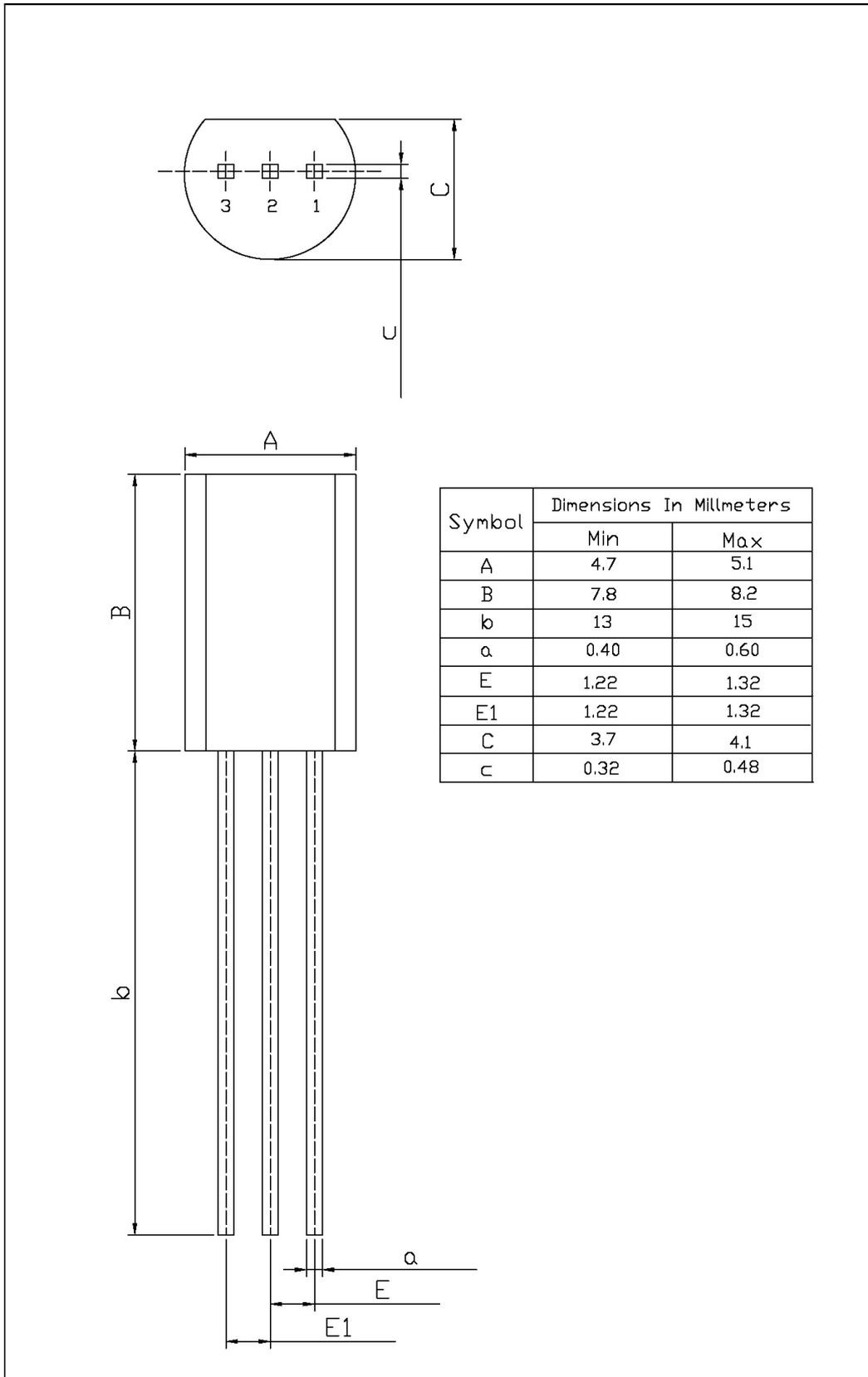

印章说明 / Marking Instructions

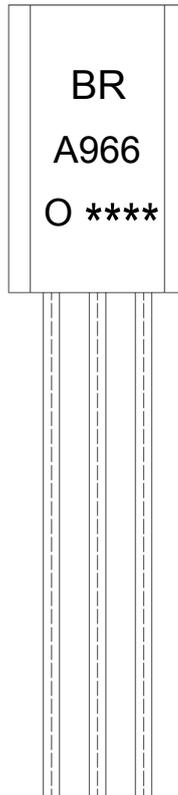

说明：

- BR: 为公司代码
- A966 : 为型号代码
- O: 为 h_{FE} 分档代码
- **** : 为生产批号代码，随生产批号变化。

Note:

- BR: Company Code.
- A966: Product Type.
- O: h_{FE} Classifications Symbol
- ****: Lot No. Code,code change with Lot No.

波峰焊温度曲线图(无铅) / Temperature Profile for Dip Soldering(Pb-Free)

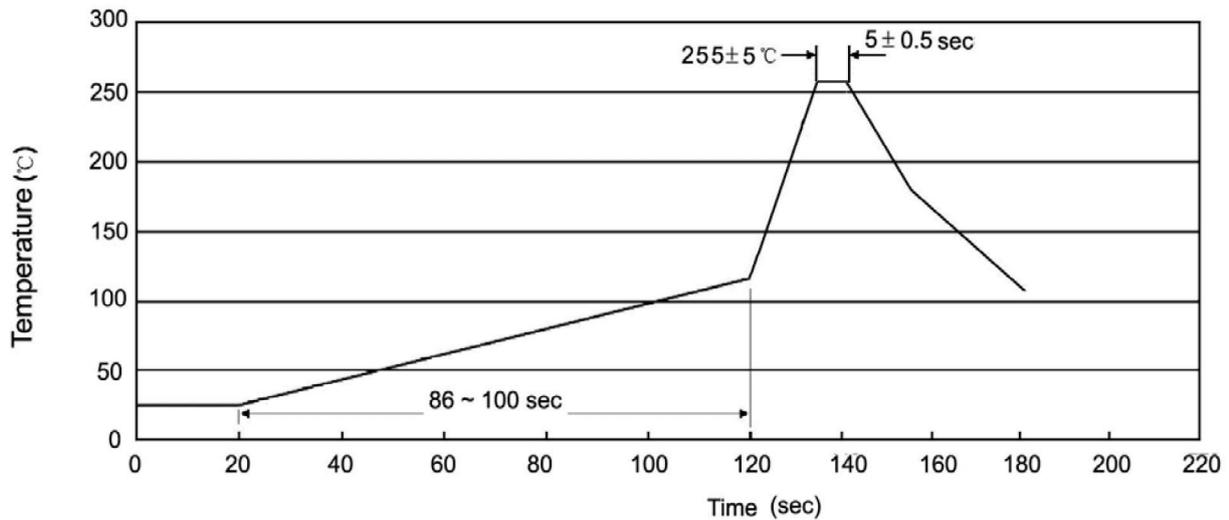

说明：

- 1、预热温度 25 ~ 150°C，时间 60 ~ 90sec;
- 2、峰值温度 255±5°C，时间持续为 5±0.5sec;
- 3、焊接制程冷却速度为 2 ~ 10°C/sec.

Note:

- 1.Preheating:25~150°C, Time:60~90sec.
- 2.Peak Temp.:255±5°C, Duration:5±0.5sec.
3. Cooling Speed: 2~10°C/sec.

耐焊接热试验条件 / Resistance to Soldering Heat Test Conditions

温度：270±5°C 时间：10±1 sec. Temp.:270±5°C Time:10±1 sec

包装规格 / Packaging SPEC.

散件包装 / BULK

Package Type 封装形式	Units 包装数量					Dimension 包装尺寸 (unit: mm3)		
	Units/Bag 只/袋	Bags/Inner Box 袋/盒	Units/Inner Box 只/盒	Inner Boxes/Outer Box 盒/箱	Units/Outer Box 只/箱	Bag 袋	Inner Box 盒	Outer Box 箱
TO-92LM	1,000	8	8,000	5	40,000	135×190	237×172×102	560×245×195

编带包装 / AMMO

Package Type 封装形式	Units 包装数量					Dimension 包装尺寸 (unit: mm3)	
	Units/tape 只/纸带	Tape/Inner Box 纸带/盒	Rows/Inner Box 纸带层/盒	Inner Boxes/Outer Box 盒/箱	Units/Outer Box 只/箱	Inner Box 盒	Outer Box 箱
TO-92LM	2,500	1	100	10	25,000	328×230×42	小箱 480×346×235 大箱 547×407×268

使用说明 / Notices