

描述 / Descriptions

TO-220F 塑封封装 NPN 半导体三极管。Silicon NPN transistor in a TO-220F Plastic Package.

特征 / Features

耐压高,开关速度快。

High voltage, high speed switching.

用途 / Applications

开关调整, 高压开关, 快速 DC-DC 转换。

Switching regulator applications, High voltage switching applications, High speed DC-DC converter applications.

内部等效电路 / Equivalent Circuit

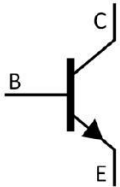

引脚排列 / Pinning

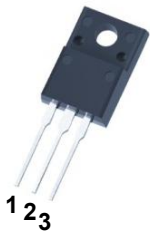

PIN1 : Base PIN 2 : Collector PIN 3 : Emitter

放大及印章代码 / h_{FE} Classifications & Marking

见印章说明。See Marking Instructions .

极限参数 / Absolute Maximum Ratings(Ta=25°C)

参数 Parameter	符号 Symbol	数值 Rating	单位 Unit
Collector to Base Voltage	V_{CBO}	900	V
Collector to Emitter Voltage	V_{CEO}	500	V
Emitter to Base Voltage	V_{EBO}	7.0	V
Collector Current - Continuous	I_C	7.0	A
Peak Collector Current	I_{cm}	14	A
Collector Power Dissipation	$P_C(T_c=25^\circ C)$	45	W
Junction Temperature	T_j	150	°C
Storage Temperature Range	T_{stg}	-55~150	°C

电性能参数 / Electrical Characteristics(Ta=25°C)

参数 Parameter	符号 Symbol	测试条件 Test Conditions	最小值 Min	典型值 Typ	最大值 Max	单位 Unit
Collector to Base Breakdown Voltage	V_{CBO}	$I_C=1mA$ $I_B=0$	900			V
Collector to Emitter Breakdown Voltage	V_{CEO}	$I_C=10mA$ $I_B=0$	500			V
Collector Cut-Off Current	I_{CEO}	$V_{CE}=500V$ $I_E=0$			250	μA
Emitter Cut-Off Current	I_{EBO}	$V_{EB}=5V$ $I_C=0$			10	μA
Collector Cut-Off Current	I_{CBO}	$V_{CB}=900V$ $I_C=0$			100	μA
DC Current Gain	$h_{FE(1)}$	$V_{CE}=5.0V$ $I_C=0.6A$	15		40	
	$h_{FE(2)}$	$V_{CE}=5.0V$ $I_C=3.0A$	8.0			
Collector to Emitter Saturation Voltage	$V_{CE(sat)}$	$I_C=3.0A$ $I_B=0.6A$			2.0	V
Base to Emitter Saturation Voltage	$V_{BE(sat)}$	$I_C=3.0A$ $I_B=0.6A$			1.5	V
Collector output capacitance	C_{OB}	$V_{CB}=10V$ $f=1MHz$		80		pF
Transition Frequency	f_T	$V_{CE}=10V$ $I_C=0.6A$		18		MHz
Storage Time	t_S	$V_{CC}=5V$ (UI9600)	3.0		8.0	μs
Fall Time	t_F				0.8	μs

电参数曲线图 / Electrical Characteristic Curve

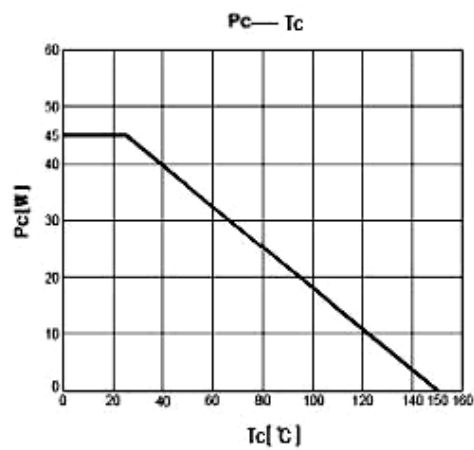
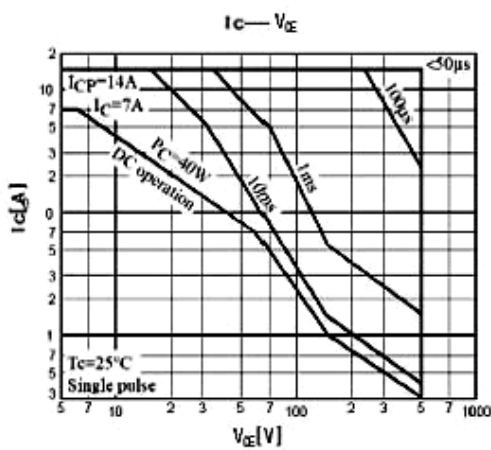
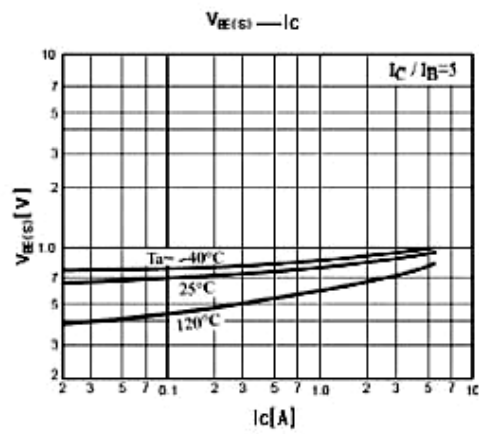
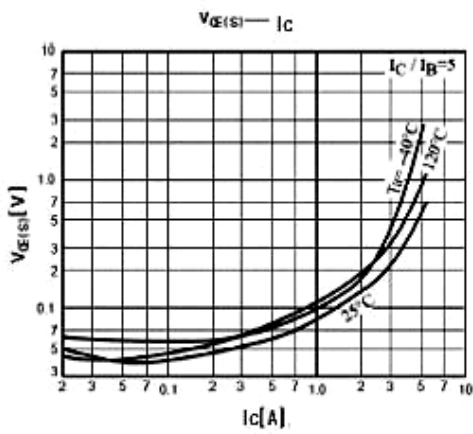
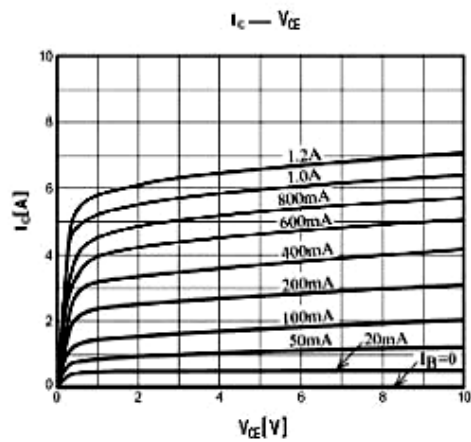
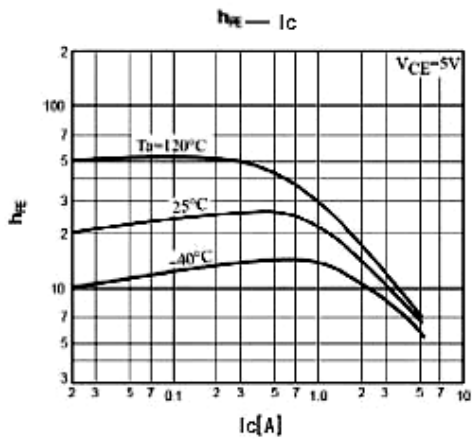

外形尺寸图 / Package Dimensions

T0-220F

单位: mm

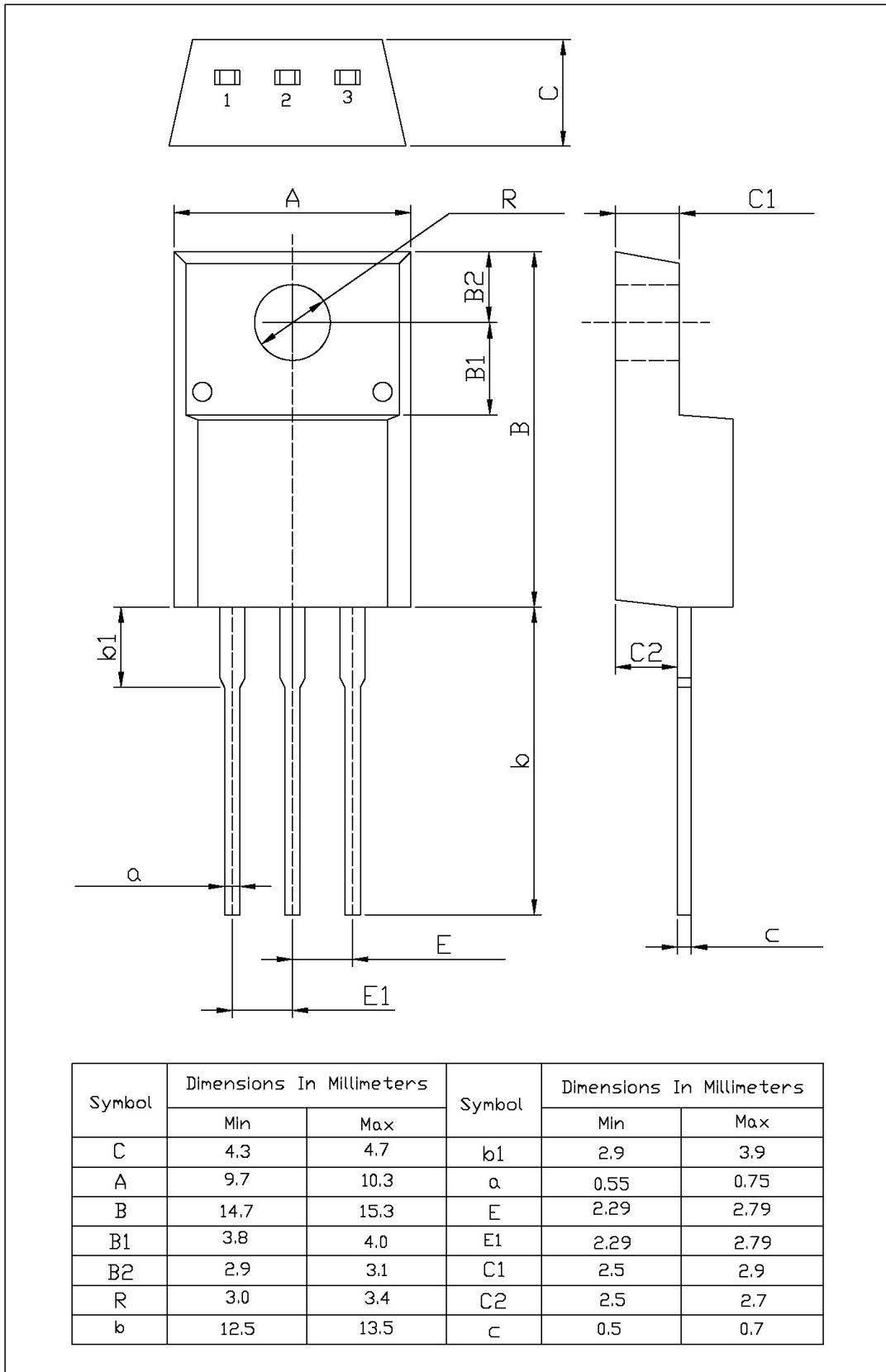

印章说明 / Marking Instructions

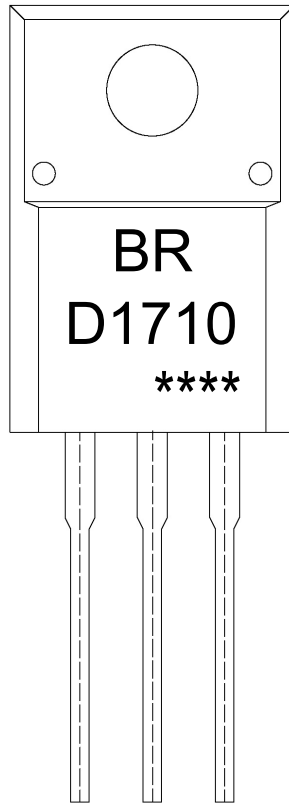

说明：

BR： 为公司代码

D1710： 为型号代码

****： 为生产批号代码，随生产批号变化。

Note:

BR: Company Code.

D1710: Product Type.

****: Lot No. Code, code change with Lot No.

波峰焊温度曲线图(无铅) / Temperature Profile for Dip Soldering(Pb-Free)



说明：

- 1、预热温度 25 ~ 150°C，时间 60 ~ 90sec；
- 2、峰值温度 255±5°C，时间持续为 5±0.5sec；
- 3、焊接制程冷却速度为 2 ~ 10°C/sec.

Note:

- 1.Preheating:25~150°C, Time:60~90sec.
- 2.Peak Temp.:255±5°C, Duration:5±0.5sec.
3. Cooling Speed: 2~10°C/sec.

耐焊接热试验条件 / Resistance to Soldering Heat Test Conditions

温度：270±5°C

时间：10±1 sec.

Temp.:270±5°C

Time:10±1 sec

包装规格 / Packaging SPEC.

散件包装 / BULK

Package Type 封装形式	Units 包装数量					Dimension 包装尺寸 (unit: mm ³)		
	Units/Bag 只/袋	Bags/Inner Box 袋/盒	Units/Inner Box 只/盒	Inner Boxes/Outer Box 盒/箱	Units/Outer Box 只/箱	Bag 袋	Inner Box 盒	Outer Box 箱
TO-220/F	200	10	2,000	5	10,000	135×190	237×172×102	560×245×195

套管包装 / TUBE

Package Type 封装形式	Units 包装数量					Dimension 包装尺寸 (unit: mm ³)		
	Units/Tube 只/套管	Tubes/Inner Box 套管/盒	Units/Inner Box 只/盒	Inner Boxes/Outer Box 盒/箱	Units/Outer Box 只/箱	Tube 套管	Inner Box 盒	Outer Box 箱
TO-220/F	50	20	1,000	5	5,000	532×31.4×5.5	555×164×50	575×290×180

使用说明 / Notices