

描述 / Descriptions

SOT-323 塑封封装 NPN 半导体三极管。Silicon NPN transistor in a SOT-323 Plastic Package.

特征 / Features

大电流，低电压，与 BC807W 互补。

High current, low voltage complementary pair with BC807W.

用途 / Applications

用于一般放大及开关电路。

General purpose switching and amplification.

内部等效电路 / Equivalent Circuit

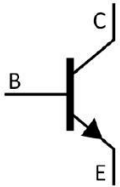

引脚排列 / Pinning

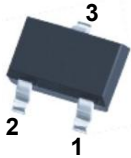

PIN1 : Emitter

PIN 2 : Base

PIN 3 : Collector

印章代码 / Marking

h_{FE} Classifications Symbol	16	25	40
h_{FE} Range	100~250	160~400	250~600
Marking	H6A	H6B	H6C

极限参数 / Absolute Maximum Ratings(Ta=25°C)

参数 Parameter	符号 Symbol	数值 Rating	单位 Unit
Collector to Base Voltage	V_{CBO}	50	V
Collector to Emitter Voltage	V_{CEO}	45	V
Emitter to Base Voltage	V_{EBO}	5.0	V
Collector Current - Continuous	I_C	500	mA
Peak Collector Current - Continuous	I_{CM}	1.0	A
Collector Power Dissipation	P_C	200	mW
Junction Temperature	T_j	150	°C
Storage Temperature Range	T_{stg}	-55~150	°C

电性能参数 / Electrical Characteristics(Ta=25°C)

参数 Parameter	符号 Symbol	测试条件 Test Conditions	最小值 Min	典型值 Typ	最大值 Max	单位 Unit
Collector Cut-Off Current	I_{CBO}	$V_{CB}=20V$ $I_E=0$			5.0	μA
Emitter Base Cut-Off Current	I_{EBO}	$V_{EB}=5.0V$ $I_C=0$			0.1	μA
DC Current Gain	h_{FE}	$V_{CE}=1.0V$ $I_C=100mA$	100		600	
Collector to Emitter Saturation Voltage	$V_{CE(sat)}$	$I_C=500mA$ $I_B=50mA$			0.7	V
Base to Emitter Voltage	V_{BE}	$V_{CE}=1.0V$ $I_C=500mA$			1.2	V
Transition Frequency	f_T	$V_{CE}=5V$ $f=100MHz$ $I_C=10mA$	100			MHz
Collector Capacitance	C_C	$V_{CB}=10V$ $f=1.0MHz$ $I_E=i_e=0$		5.0		pF

电参数曲线图 / Electrical Characteristic Curve

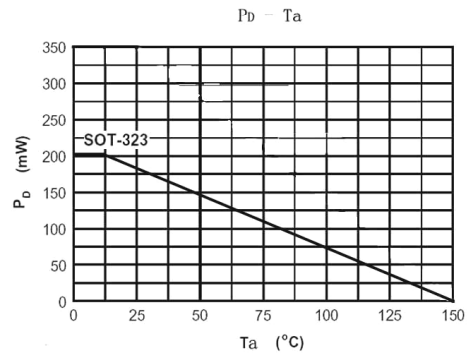
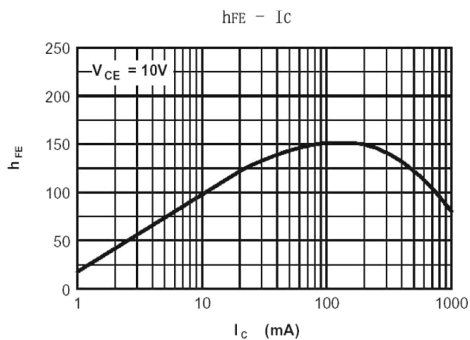
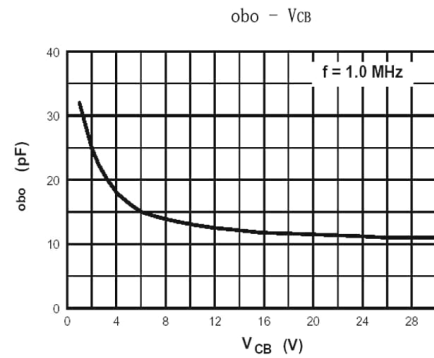
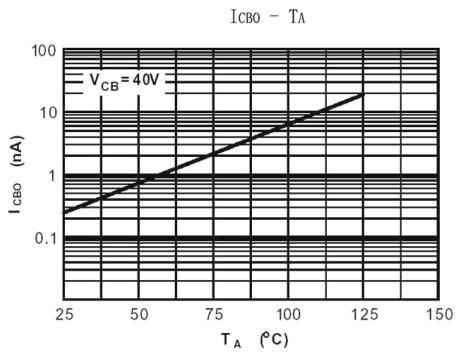
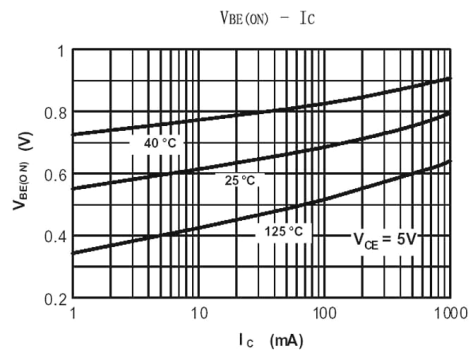
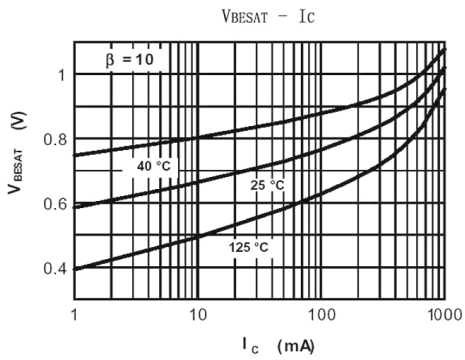
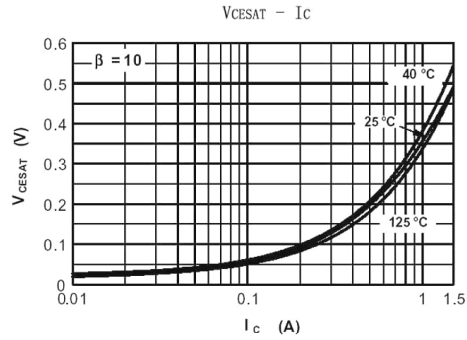
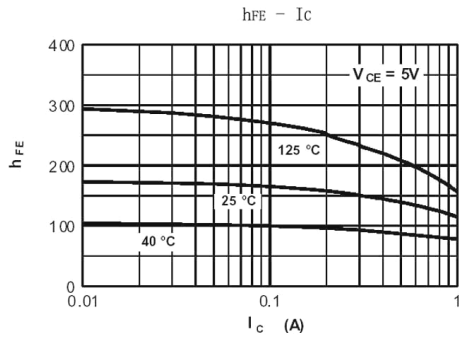

外形尺寸图 / Package Dimensions

SOT-323

单位: mm

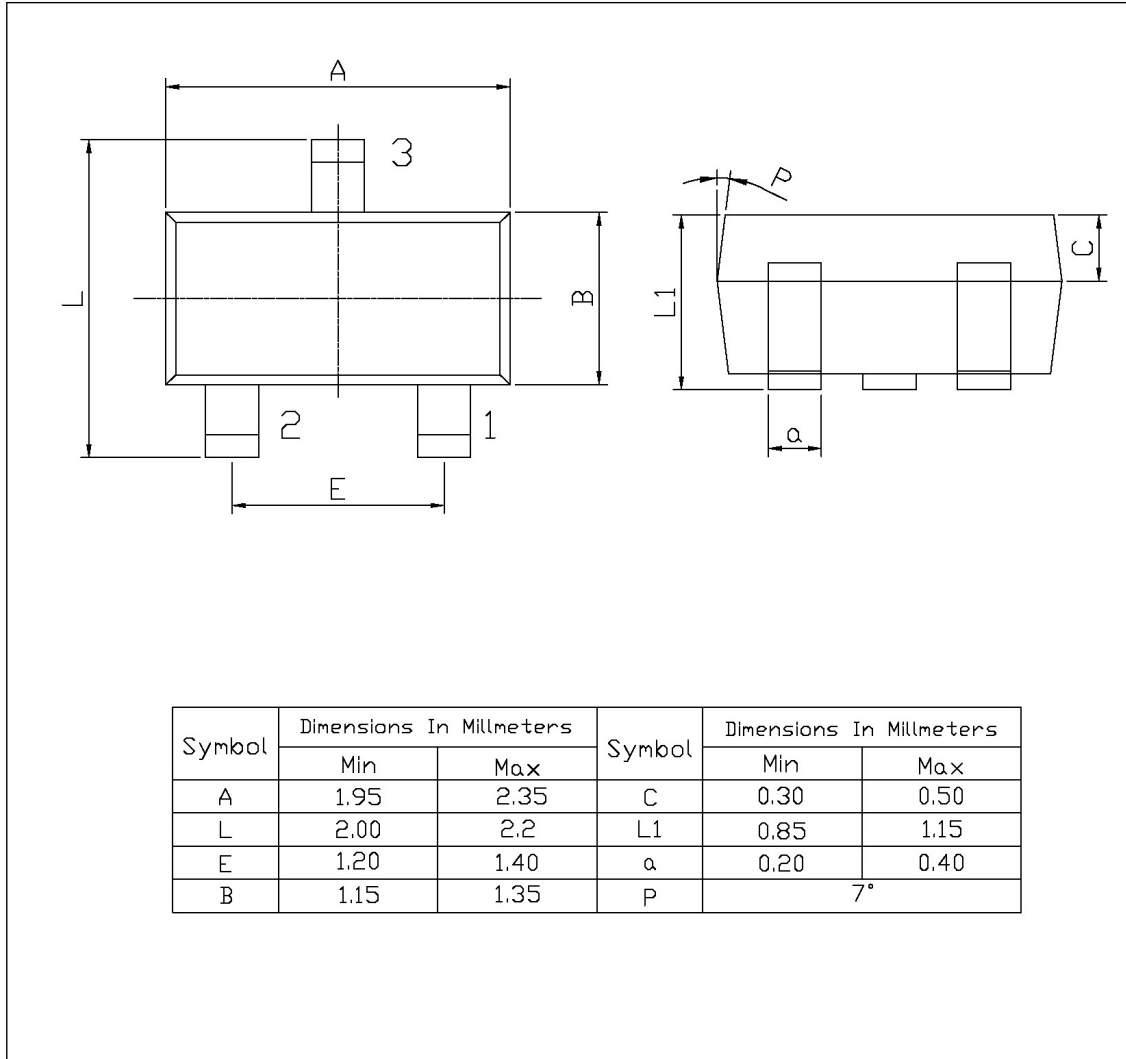

印章说明 / Marking Instructions

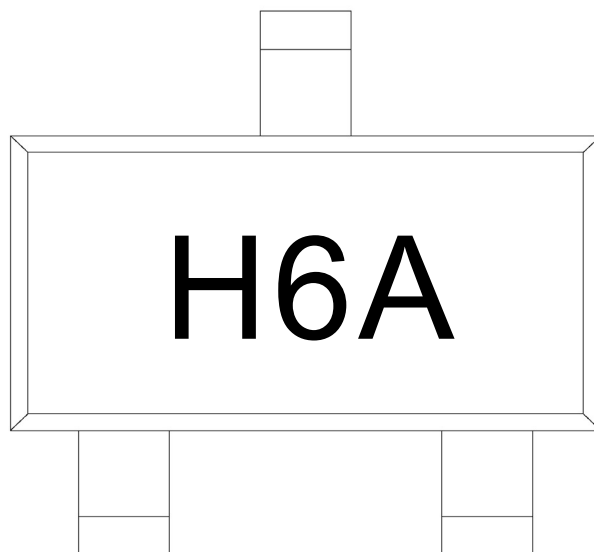

说明：

H： 为公司代码

6A： 为型号代码

Note:

H: Company Code.

6A: Product Type.

回流焊温度曲线图(无铅) / Temperature Profile for IR Reflow Soldering(Pb-Free)



说明：

- 1、预热温度 25 ~ 150°C，时间 60 ~ 90sec;
- 2、峰值温度 245±5°C，时间持续为 5±0.5sec;
- 3、焊接制程冷却速度为 2 ~ 10°C/sec.

Note:

- 1.Preheating:25~150°C, Time:60~90sec.
- 2.Peak Temp.:245±5°C, Duration:5±0.5sec.
3. Cooling Speed: 2~10°C/sec.

耐焊接热试验条件 / Resistance to Soldering Heat Test Conditions

温度：260±5°C

时间：10±1 sec.

Temp.:260±5°C

Time:10±1 sec

包装规格 / Packaging SPEC.

卷盘包装 / REEL

Package Type 封装形式	Units 包装数量					Dimension 包装尺寸 (unit: mm ³)		
	Units/Reel 只/卷盘	Reels/Inner Box 卷盘/盒	Units/Inner Box 只/盒	Inner Boxes/Outer Box 盒/箱	Units/Outer Box 只/箱	Reel	Inner Box 盒	Outer Box 箱
SOT-323	3,000	10	30,000	6	180,000	7" ×8	180×120×180	390×385×205

使用说明 / Notices