

## 描述 / Descriptions

TO-263 塑封封装 双向可控硅。 Triac in a TO-263 Plastic Package.

## 特征 / Features

中电流可控硅，高转换性能，低通态压降，高可靠性和稳定性，热敏电阻特性低。

Medium current triac, High commutation performances, Low on state voltage drop, High reliability and stability, Low thermal resistance.

## 用途 / Applications

主要应用于开关电路，如固态继电器、温控器、马达驱动和马达调速控制、相位控制调光器等。

They can be used as an ON/OFF function in applications such as static relays, heating regulation, induction motor starting circuits or phase control operation in light dimmers, motor speed controllers, etc.

## 内部等效电路 / Equivalent Circuit



## 引脚排列 / Pinning



PIN 1 : Main Terminal 1

PIN 2、 4 : Main Terminal 2

PIN 3 : Gate

## 放大及印章代码 / h<sub>FE</sub> Classifications & Marking

见印章说明。 See Marking Instructions.

**极限参数 / Absolute Maximum Ratings(Ta=25°C)**

参数 Parameter	符号 Symbol	数值 Rating	单位 Unit
Repetitive peak off-state voltages	$V_{DRM}/V_{RRM}$	600/800	V
On-state rms current(full sine wave $T_C=86^\circ\text{C}$ )	$I_{T(RMS)}$	16	A
Non repetitive surge peak on-state current(full cycle, $T_j$ initial = 25 °C)	$I_{TSM}(F=50\text{Hz}$ $t=20\text{ms})$	160	A
Non repetitive surge peak on-state current(full cycle, $T_j$ initial = 25 °C)	$I_{TSM}(F=60\text{Hz}$ $t=16.7\text{ms})$	168	A
$I^2t$ value for fusing	$I^2t_{(tp=10\text{ms})}$	144	$\text{A}^2\text{s}$
Critical rate of rise of on-state current $I_G = 2 \times I_{GT}$ , $t_r \leq 100 \text{ ns}$ ( $F=120\text{Hz}$ $T_j=125^\circ\text{C}$ )	$di/dt$	50	$\text{A}/\mu\text{s}$
Non repetitive surge peak off-state Voltage( $t_p = 10 \text{ ms}$ $T_j = 25^\circ\text{C}$ )	$V_{DSM}/V_{RSM}$	$V_{DRM}/V_{RRM}$ + 100	V
Peak gate current( $t_p = 20\mu\text{s}$ $T_j=125^\circ\text{C}$ )	$I_{GM}$	4.0	A
Average gate power dissipation( $T_j=125^\circ\text{C}$ )	$P_{G(AV)}$	1.0	W
Maximum operating Junction Temperature	$T_j$	-40 ~ 125	$^\circ\text{C}$
Storage Temperature Range	$T_{stg}$	-40 ~ 150	$^\circ\text{C}$
Junction to ambient	$R_{th(j-a)}$	60	$^\circ\text{C}/\text{W}$
Junction to case (AC)	$R_{th(j-c)}$	2.1	$^\circ\text{C}/\text{W}$

**电性能参数 / Electrical Characteristics(Ta=25°C)**
**免缓冲器和逻辑电平 ( 3 象限 ) / Snubberless and logic level ( 3 quadrants)**

符号 Symbol	测试条件 Test Conditions	信号区 Quadrant		BTB16			单位 Unit
				SW	CW	BW	
$I_{GT}^{(1)}$	$V_D=12\text{V}$ $R_L=33\Omega$	I-II-III	Max.	10	35	50	mA
$V_{GT}$	$V_D=12\text{V}$ $R_L=33\Omega$	I-II-III	Max.	1.3			V
$V_{GD}$	$V_D=V_{DRM}$ $R_L=3.3\text{K}\Omega$ $T_j=125^\circ\text{C}$	I-II-III	Min.	0.2			V
$I_H^{(2)}$	$I_T=500\text{mA}$		Max.	15	35	50	mA
$I_L$	$I_G=1.2I_{GT}$	I-III	Max.	25	50	70	mA
		II		30	60	80	
$dV/dt^{(2)}$	$V_D = 67\% V_{DRM}$ gate open $T_j = 125^\circ\text{C}$		Min.	40	500	1000	$\text{V}/\mu\text{s}$
$(di/dt)_c^{(2)}$	$(dV/dt)_c = 0.1\text{V}/\mu\text{s}$ $T_j = 125^\circ\text{C}$		Min.	8.5	-	-	A/mS
	$(dV/dt)_c = 10\text{V}/\mu\text{s}$ $T_j = 125^\circ\text{C}$		Min.	3.0	-	-	
	Without snubber $T_j = 125^\circ\text{C}$		Min.	-	8.5	14	

Note 1: minimum  $I_{GT}$  is guaranteed at 5% of  $I_{GT}$  max.

Note 2: for both polarities of A2 referenced to A1.

## 电性能参数 / Electrical Characteristics(Ta=25°C)

## 标准 (4象限) / Standard (4 quadrants)

符号 Symbol	测试条件 Test Conditions	信号区 Quadrant		BTB16		单位 Unit
				C	B	
$I_{GT}^{(1)}$	$V_D=12V$ $R_L=33\Omega$	I-II-III IV	Max.	25 50	50 100	mA
$V_{GT}$	$V_D=12V$ $R_L=33\Omega$	ALL	Max.	1.3		V
$V_{GD}$	$V_D=V_{DRM}$ $R_L=3.3K\Omega$ $T_j=125^\circ C$	ALL	Min.	0.2		V
$I_H^{(2)}$	$I_T=500mA$		Max.	25	50	mA
$I_L$	$I_G=1.2I_{GT}$	I-III- IV	Max.	40	60	mA
		II		80	120	
$(dV/dt)^{(2)}$	$V_D=67\%$ $V_{DRM}$ gate open $T_j=125^\circ C$		Min.	200	400	V/ $\mu s$
$(dV/dt)c^{(2)}$	$(dI/dt)c=7A/ms$ $T_j=125^\circ C$		Min.	5.0	10	

Note 1: minimum  $I_{GT}$  is guaranteed at 5% of  $I_{GT}$  max.

Note 2: for both polarities of A2 referenced to A1.

## 电性能参数 / Electrical Characteristics(Ta=25°C)

符号 Symbol	测试条件 Test Conditions			数值 Value	单位 Unit
$V_{TM}^{(2)}$	$I_{TM}=22.5A$	$t_p=380\mu s$ $T_j=25^\circ C$	Max.	1.55	V
$V_{to}^{(2)}$	Threshold voltage $T_j=125^\circ C$		Max.	0.85	V
$R_d^{(2)}$	Dynamic resistance $T_j=125^\circ C$		Max.	25	m $\Omega$
$I_{DRM}$ $I_{RRM}$	$V_{DRM} = V_{RRM}$	$T_j=25^\circ C$	Max.	5.0	$\mu A$
		$T_j=125^\circ C$	Max.	2.0	mA

Note2. for both polarities of A2 referenced to A1

**电参数曲线图 / Electrical Characteristic Curve**

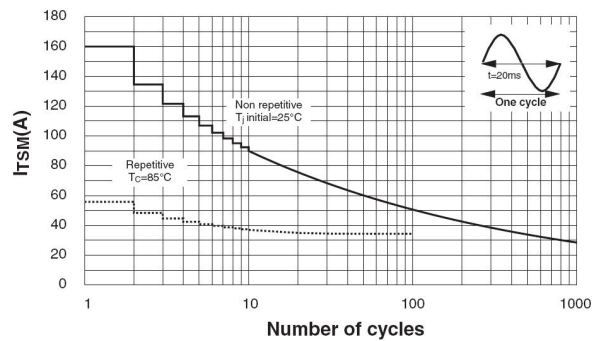
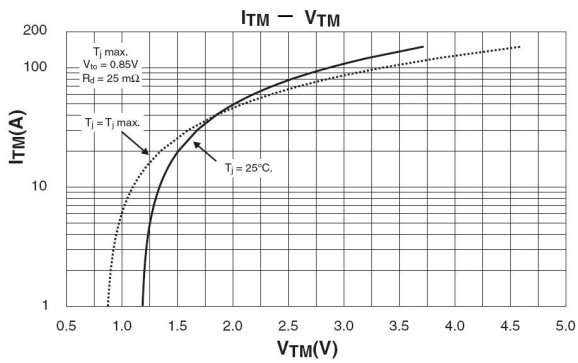
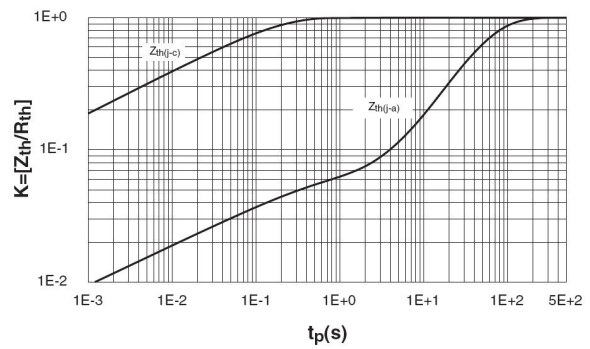
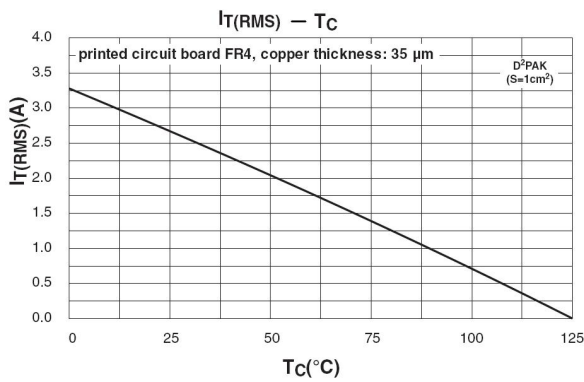
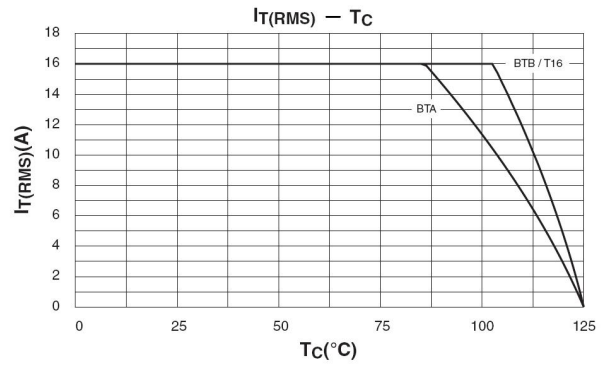
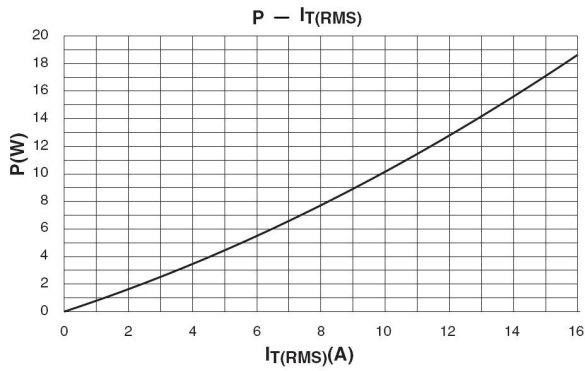

电参数曲线图 / Electrical Characteristic Curve

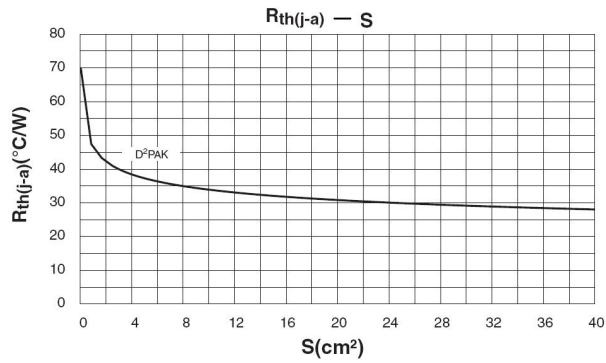
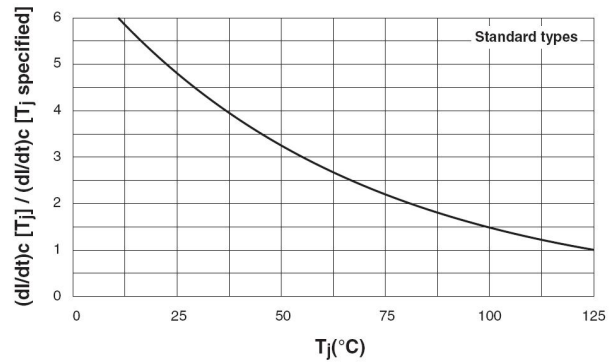
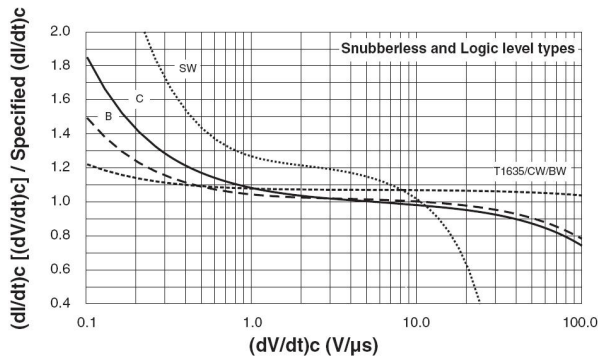
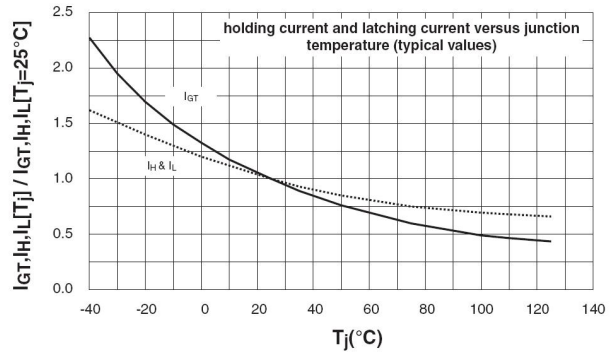
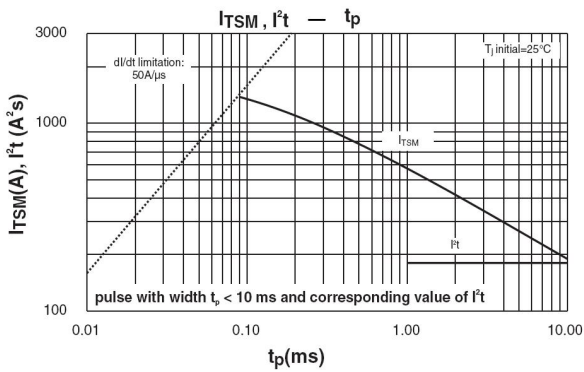

**外形尺寸图 / Package Dimensions**

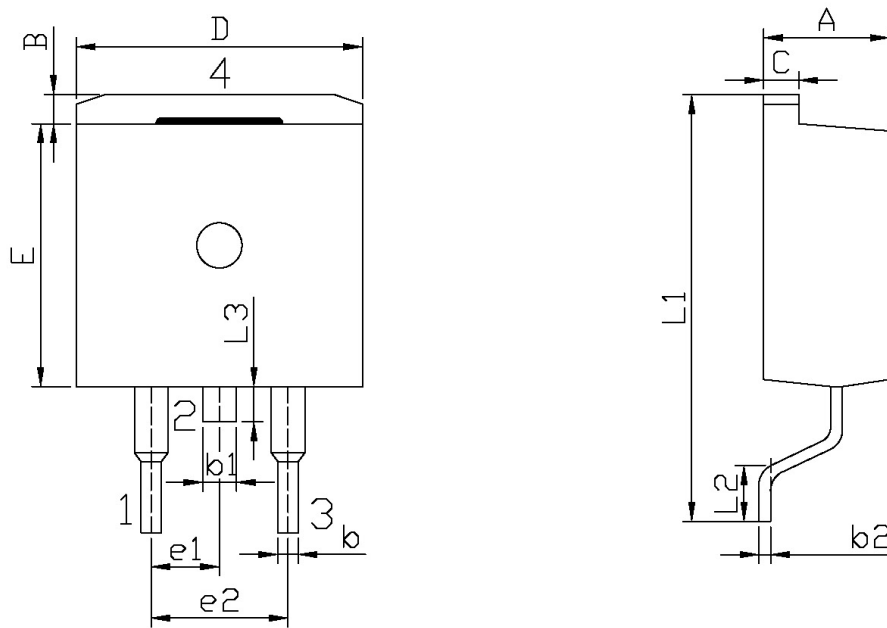

单位: mm

Symbol	Dimensions In Millimeters		Symbol	Dimensions In Millimeters	
	Min	Max		Min	Max
A	4.30	4.70	E	9.00	9.40
B	1.00	1.40	e1	2.34	2.74
b	0.70	0.90	e2	4.88	5.28
b1	1.15	1.35	L1	15.00	16.00
b2	0.40	0.60	L2	2.24	2.84
C	1.20	1.40	L3	1.20	1.60
D	9.80	10.20			

T0-263

印章说明 / Marking Instructions

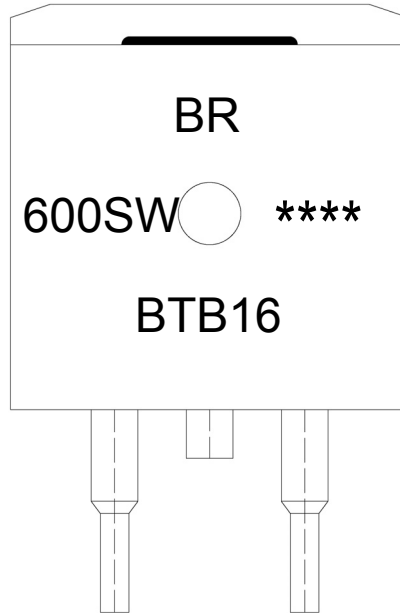

说明：

BR： 为公司代码

BTB16： 为产品型号

600SW: 为  $V_{RRM}$  和  $I_{GT}$  分档代码

\*\*\*\*： 为生产批号代码，随生产批号变化。

Note:

BR: Company Code

BTB16: Product Type.

600SW:  $V_{RRM}/I_{GT}$  Bracket code

\*\*\*\*: Lot No. Code, code change with Lot No.

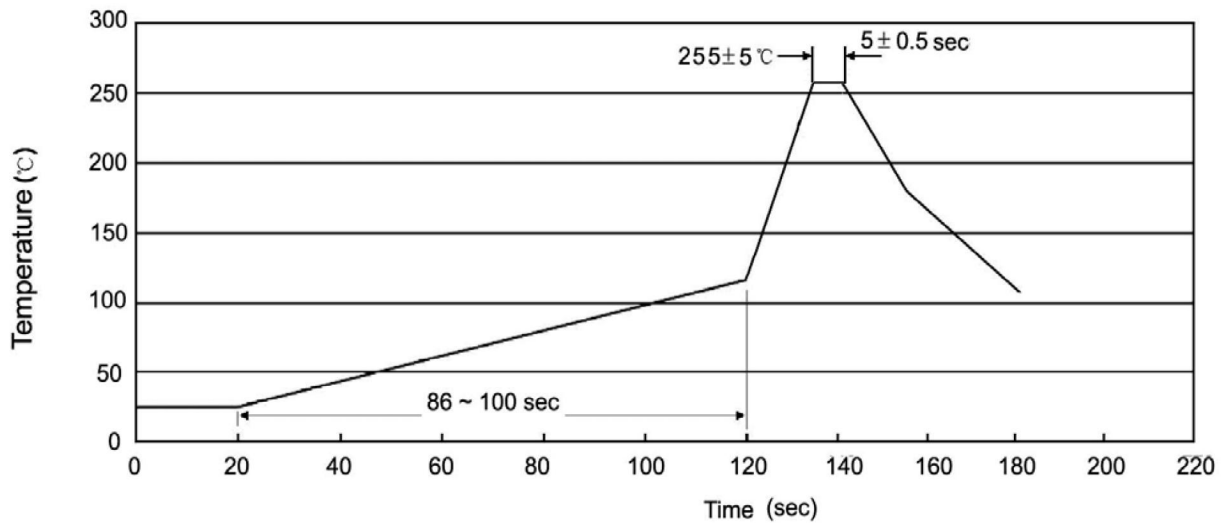
**波峰焊温度曲线图(无铅) / Temperature Profile for Dip Soldering(Pb-Free)**

说明：

- 1、预热温度 25 ~ 150°C，时间 60 ~ 90sec；
- 2、峰值温度 255±5°C，时间持续为 5±0.5sec；
- 3、焊接制程冷却速度为 2 ~ 10°C/sec.

Note:

- 1.Preheating:25~150°C, Time:60~90sec.
- 2.Peak Temp.:255±5°C, Duration:5±0.5sec.
3. Cooling Speed: 2~10°C/sec.

**耐焊接热试验条件 / Resistance to Soldering Heat Test Conditions**

温度：270±5°C

时间：10±1 sec.

Temp.:270±5°C

Time:10±1 sec

**包装规格 / Packaging SPEC.**

散件包装 / BULK

Package Type 封装形式	Units 包装数量					Dimension 包装尺寸 (unit: mm <sup>3</sup> )		
	Units/Bag 只/袋	Bags/Inner Box 袋/盒	Units/Inner Box 只/盒	Inner Boxes/Outer Box 盒/箱	Units/Outer Box 只/箱	Bag 袋	Inner Box 盒	Outer Box 箱
TO-263	800	1	800	6	48,00	13" x24	360×360×50	380×335×366

套管包装 / TUBE

Package Type 封装形式	Units 包装数量					Dimension 包装尺寸 (unit: mm <sup>3</sup> )		
	Units/Tube 只/套管	Tubes/Inner Box 套管/盒	Units/Inner Box 只/盒	Inner Boxes/Outer Box 盒/箱	Units/Outer Box 只/箱	Tube 套管	Inner Box 盒	Outer Box 箱
TO-263	50	20	1,000	5	5,000	532×33×7.0	555×164×50	575×290×180

**使用说明 / Notices**