

BRCS150N10SZC

Rev.A Oct.-2021

描述 / Descriptions

PDFN5*6 封装 N 沟道场效应管。

N-Channel MOSFET in a PDFN5*6 Plastic Package .

特征 / Features

低电阻可最大地降低导电损耗；低栅极电荷，可实现快速切换；低热阻。无卤产品。

Low $R_{DS(ON)}$ to minimize conductive loss; low Gate Charge for fast switching; Low Thermal resistance. HF Product.

用途 / Applications

电池管理，MB/NB/UMPC/VGA 高频负载点同步 Buck 变换器，联网直流-直流电力系统，负荷开关。

Battery Management, High Frequency Point-of-Load Synchronous Buck Converter for MB/NB/UMPC/VGA, Networking DC-DC Power System, Load Switch.

内部等效电路 / Equivalent Circuit

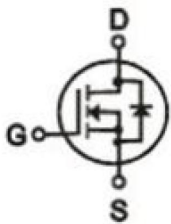

引脚排列 / Pinning

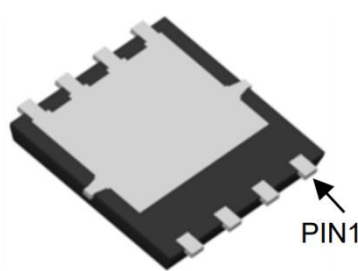
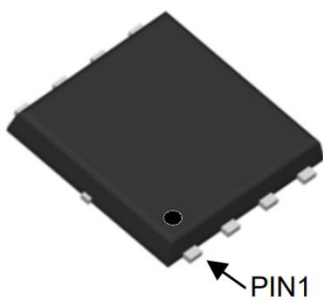

PIN1、2、3: S

PIN4: G

PIN5、6、7、8: D

Pin	极性
1	S
2	S
3	S
4	G
5	D
6	D
7	D
8	D

放大及印章代码 / h_{FE} Classifications & Marking

见印章说明。See Marking Instructions.

极限参数 / Absolute Maximum Ratings($T_a=25^\circ\text{C}$)

参数 Parameter	符号 Symbol	数值 Rating	单位 Unit
Drain-Source Voltage	V_{DS}	100	V
Continuous Drain Current	I_D	46	A
Pulsed Drain Current	I_{DM}	184	A
Gate-Source Voltage	V_{GS}	± 20	V
Power Dissipation	$P_D(T_c=25^\circ\text{C})$	78	W
Avalanche energy(L=0.5mH)	E_{AS}	24.5	mJ
Avalanche Current(L=0.5mH)	I_{AS}	7.0	A
Junction and Storage Temperature Range	T_j, T_{stg}	-55 to 150	$^\circ\text{C}$
Maximum Junction-to-Ambient	$t \leq 10\text{s}$	17	$^\circ\text{C/W}$
	Steady-State	55	
Maximum Junction-to-Case	Steady-State	1.6	

电性能参数 / Electrical Characteristics($T_a=25^\circ\text{C}$)

参数 Parameter	符号 Symbol	测试条件 Test Conditions	最小值 Min	典型值 Typ	最大值 Max	单位 Unit
Drain-Source Breakdown Voltage	BV_{DSS}	$I_D=250\mu\text{A}, V_{GS}=0\text{V}$	100	109		V
Zero Gate Voltage Drain Current	I_{DSS}	$V_{DS}=100\text{V}, V_{GS}=0\text{V}$			1	μA
Gate-Body leakage current	I_{GSS}	$V_{DS}=0\text{V}, V_{GS}=\pm 20\text{V}$			± 100	nA
Gate Threshold Voltage	$V_{GS(th)}$	$V_{DS}=V_{GS}, I_D=250\mu\text{A}$	1.0	1.7	2.5	V
Static Drain-Source On-Resistance	$R_{DS(on)}$	$V_{GS}=10\text{V}, I_D=20\text{A}$		14.8	15	m Ω
		$V_{GS}=4.5\text{V}, I_D=10\text{A}$		20.4	25	
Diode Forward Voltage	V_{SD}	$I_S=1\text{A}, V_{GS}=0\text{V}$			1.2	V
Input Capacitance	C_{iss}	$V_{DS}=25\text{V}, V_{GS}=0\text{V}$ $f=1.0\text{MHz}$		1140		pF
Output Capacitance	C_{oss}			600		
Reverse Transfer Capacitance	C_{rss}			60		
Gate resistance	R_g	$V_{GS}=0\text{V}, V_{DS}=0\text{V}$ $f=1\text{MHz}$		1.6		Ω
Total Gate Charge	$Q_{g(10V)}$	$V_{GS}=10\text{V}, V_{DS}=50\text{V},$ $I_D=20\text{A}$		32.5		nC
Total Gate Charge	$Q_{g(4.5V)}$			15.5		
Gate Source Charge	Q_{gs}			6.5		
Gate Drain Charge	Q_{gd}			5		

电性能参数 / Electrical Characteristics(Ta=25°C)

参数 Parameter	符号 Symbol	测试条件 Test Conditions	最小值 Min	典型值 Typ	最大值 Max	单位 Unit
Turn-On Delay Time	$t_{d(on)}$	$V_{GS}=10V$ $V_{DS}=50V$ $R_L=2.5\Omega$ $R_{GEN}=3\Omega$		7		ns
Turn-On Rise Time	t_r			3		
Turn-Off Delay Time	$t_{d(off)}$			27		
Turn-Off Fall Time	t_f			4		

电参数曲线图 / Electrical Characteristic Curve

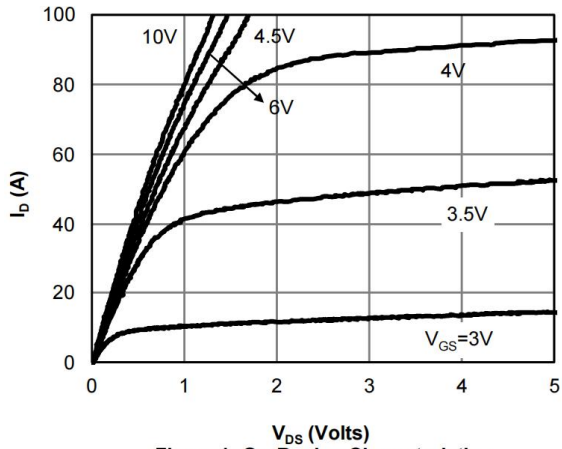

Figure 1: On-Region Characteristics

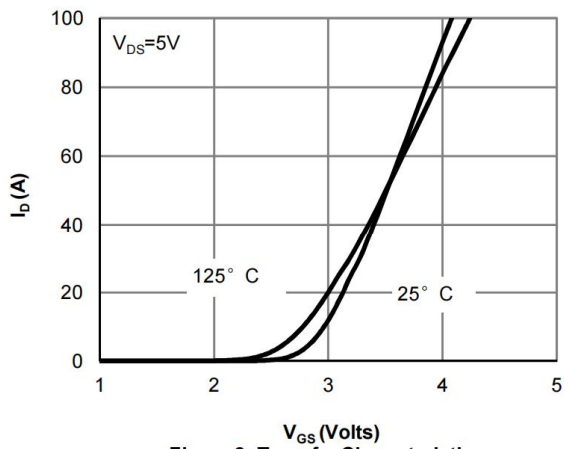

Figure 2: Transfer Characteristics

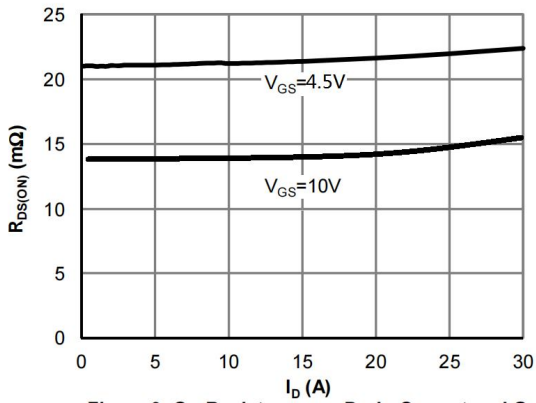

Figure 3: On-Resistance vs. Drain Current and Gate Voltage

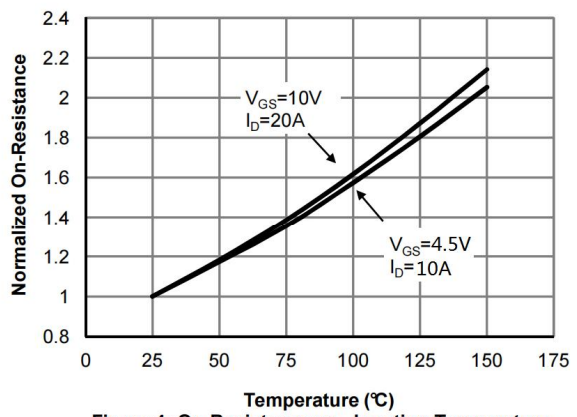

Figure 4: On-Resistance vs. Junction Temperature

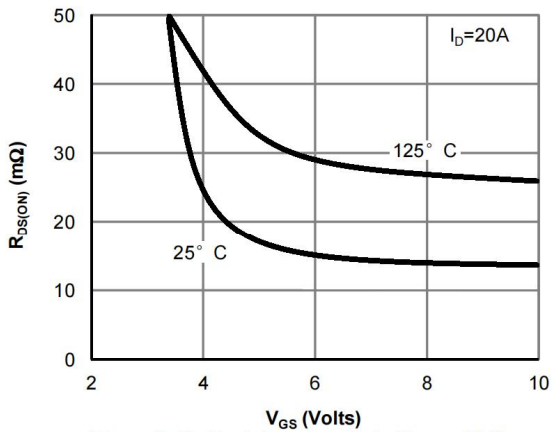

Figure 5: On-Resistance vs. Gate-Source Voltage

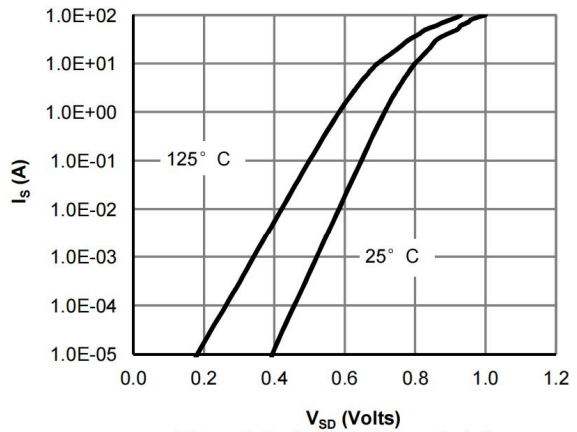

Figure 6: Body-Diode Characteristics

电参数曲线图 / Electrical Characteristic Curve

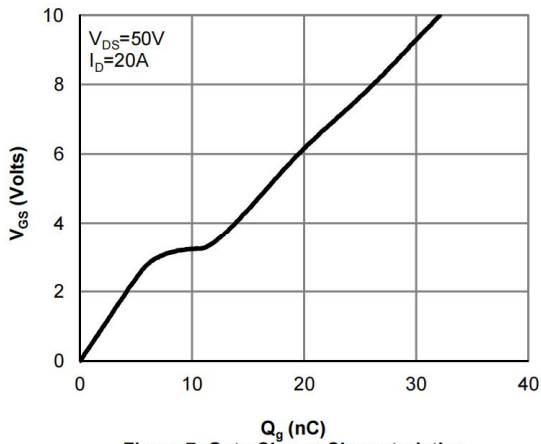

Figure 7: Gate-Charge Characteristics

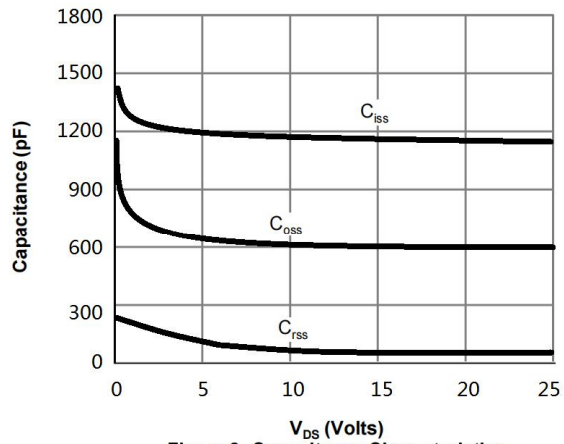

Figure 8: Capacitance Characteristics

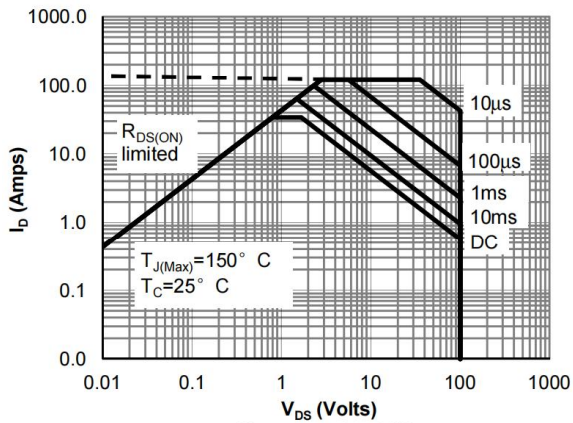

Figure 9: Maximum Forward Biased Safe Operating Area

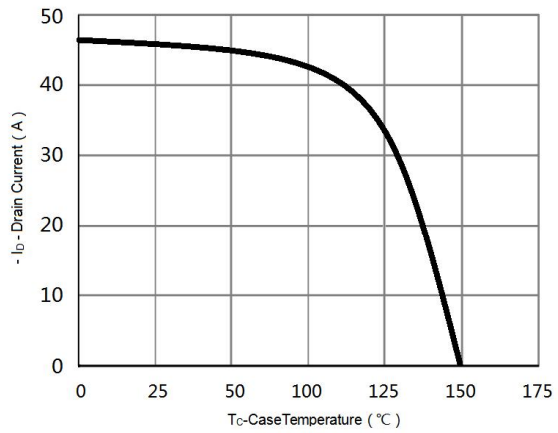

Figure 10: Maximum Continuous Drain Current Vs Case Temperature

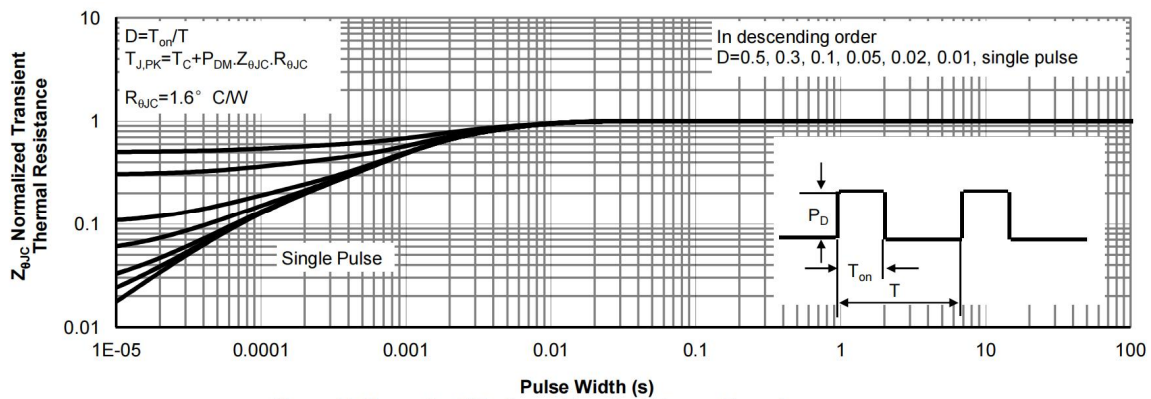

Figure 11: Normalized Maximum Transient Thermal Impedance

BRCS150N10SZC

Rev.A Oct.-2021

外形尺寸图 / Package Dimensions

PDFN5 X6

Unit:mm

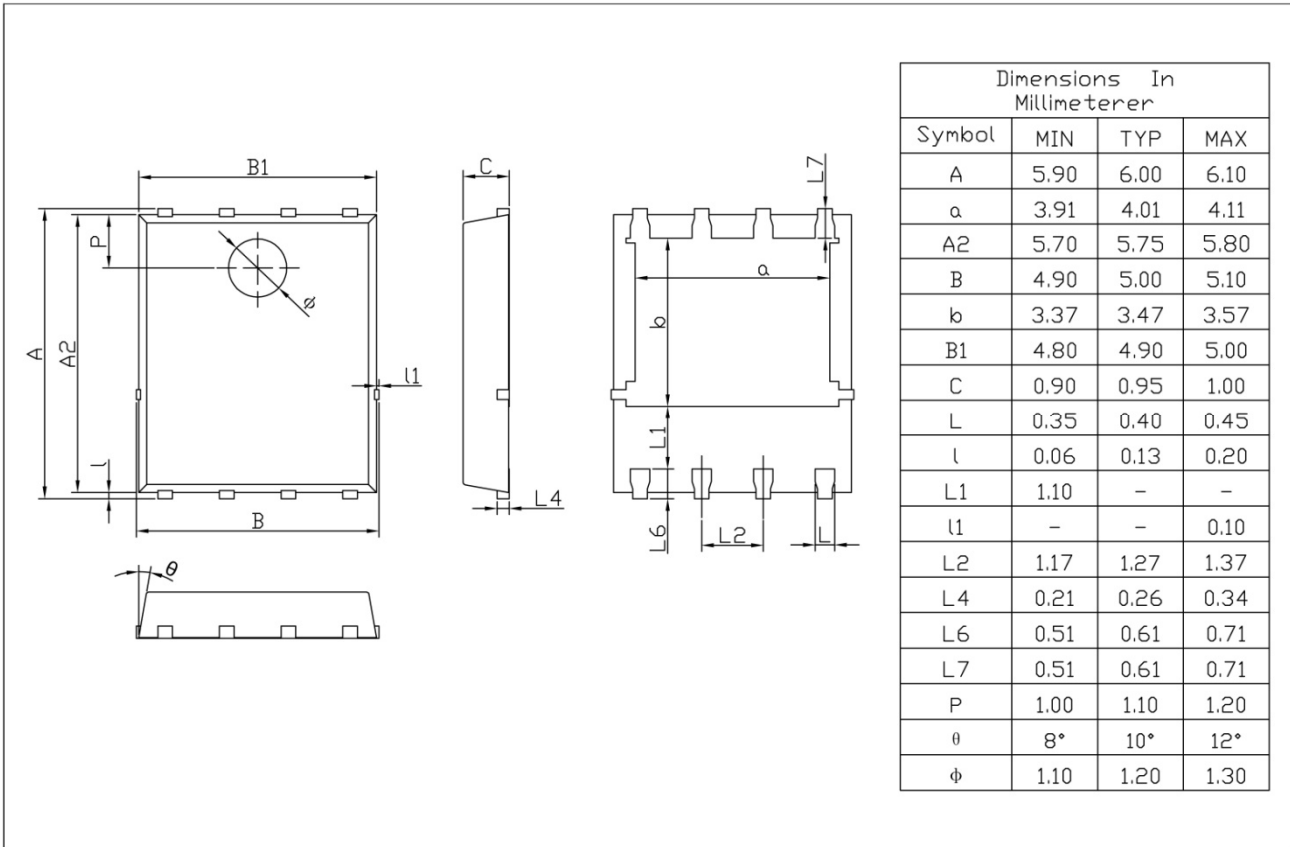

Rev.00 201812

印章说明 / Marking Instructions

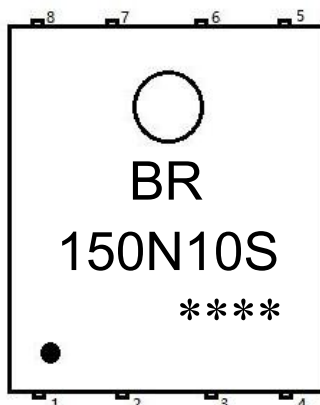

说明：

BR： 为公司代码

150N10S： 为为产品型号

Note：

BR： Company Code

150N10S： Product Type.

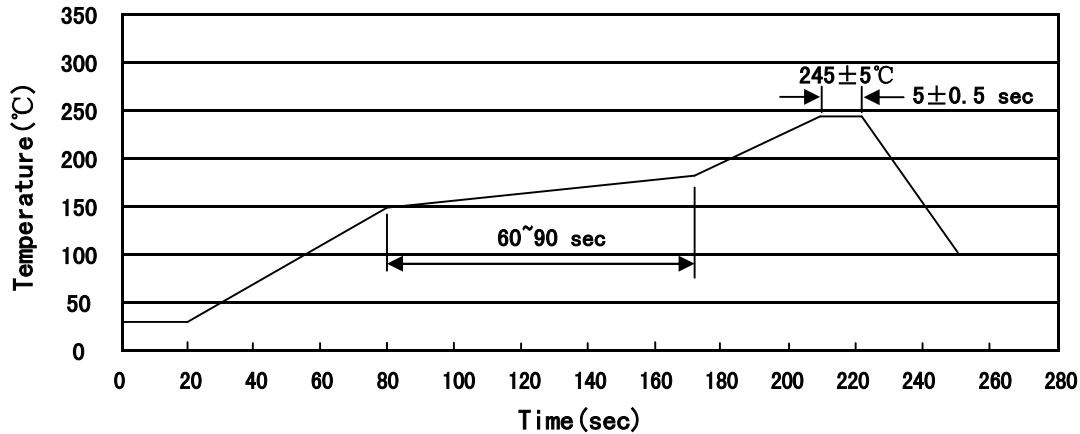
回流焊温度曲线图(无铅) / Temperature Profile for IR Reflow Soldering(Pb-Free)

说明：

- 1、预热温度 150~180°C，时间 60~90sec;
- 2、峰值温度 245±5°C，时间持续为 5±0.5sec;
- 3、焊接制程冷却速度为 2~10°C/sec.

Note:

- 1.Preheating:150~180°C, Time:60~90sec.
- 2.Peak Temp.:245±5°C, Duration:5±0.5sec.
3. Cooling Speed: 2~10°C/sec.

耐焊接热试验条件 / Resistance to Soldering Heat Test Conditions

温度：260±5°C

时间：10±1 sec.

Temp.:260±5°C

Time:10±1 sec

包装规格 / Packaging SPEC.

卷盘包装 / REEL

Package Type 封装形式	Units 包装数量					Dimension 包装尺寸 (unit: mm ³)		
	Units/Reel 只/卷盘	Reels/Inner Box 卷盘/盒	Units/Inner Box 只/盒	Inner Boxes/Outer Box 盒/箱	Units/Outer Box 只/箱	Reel	Inner Box 盒	Outer Box 箱
PDFN5*6	5000	2	10000	6	60000	13" × 12	360 × 360 × 50	380 × 335 × 366

使用说明 / Notices