

描述 / Descriptions

TO-251 塑封封装 P 沟道 MOS 场效应管。 P-CHANNEL MOSFET in a TO-251 Plastic Package.

特征 / Features

$R_{DS(on)}$ 小, 门电荷低, C_{rss} 小, 开关速度快。

Low $R_{DS(on)}$, low gate charge, low C_{rss} , fast switching.

用途 / Applications

用于低压电路如: 汽车电路、DC/DC 转换、便携式产品的电源高效转换。

Suited for low voltage applications such as automotive, DC/DC Converters, and high efficiency switching for power management in portable and battery operated products.

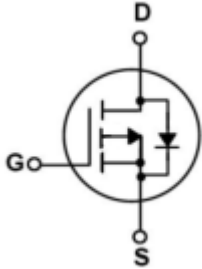
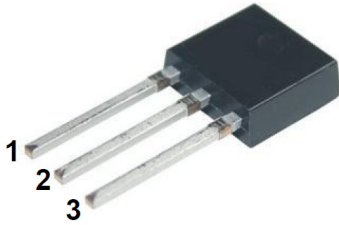
内部等效电路 / Equivalent Circuit**引脚排列 / Pinning**

PIN1 : G

PIN 2 : D

PIN 3 : S

放大及印章代码 / h_{FE} Classifications & Marking

见印章说明。 See Marking Instructions.

极限参数 / Absolute Maximum Ratings(Ta=25°C)

参数 Parameter	符号 Symbol	数值 Rating	单位 Unit
Drain-Source Voltage	V_{DSS}	-30	V
Drain Current	$I_D(T_c=25^\circ C)$	-20	A
Drain Current - Pulsed	I_{DM}	-50	A
Gate-Source Voltage	V_{GS}	± 20	V
Single Pulsed Avalanche Energy	E_{AS}	50	mJ
Power Dissipation	$P_D(T_c=25^\circ C)$	30	W
Junction Temperature Range	T_j	150	$^\circ C$
Storage Temperature Range	T_{stg}	-55~150	$^\circ C$

电性能参数 / Electrical Characteristics(Ta=25°C)

参数 Parameter	符号 Symbol	测试条件 Test Conditions	最小值 Min	典型值 Typ	最大值 Max	单位 Unit
Drain-Source Breakdown Voltage	BV_{DSS}	$V_{GS}=0V$ $I_D=-250\mu A$	-30			V
Zero Gate Voltage Drain Current	I_{DSS}	$V_{DS}=-30V$ $V_{GS}=0V$			1.0	μA
Gate-Body Leakage Current Forward	I_{GSS}	$V_{GS}=\pm 20V$ $V_{DS}=0V$			± 0.1	μA
Gate Threshold Voltage	$V_{GS(th)}$	$V_{DS}=V_{GS}$ $I_D=-250\mu A$	-1		-2.5	V
Static Drain-Source On-Resistance	$R_{DS(on)1}$	$V_{GS}=-10V$ $I_D=-8.8A$		18	23	m Ω
	$R_{DS(on)2}$	$V_{GS}=-4.5V$ $I_D=-6.7A$		27	35	m Ω
Drain-Source Diode Forward Voltage	V_{SD}	$V_{GS}=0V$ $I_S=-2.1A$		-0.73	-1.2	V
Input Capacitance	C_{iss}	$V_{DS}=-15V$ $V_{GS}=0V$ $f=1.0MHz$		1604		pF
Output Capacitance	C_{oss}			408		
Reverse Transfer Capacitance	C_{rss}			202		
Total Gate Charge	Q_g	$V_{DS}=-15V$ $I_D=-8.8A$ $V_{GS}=-5V$		17	24	nC
Turn-On Delay Time	$t_{d(on)}$	$V_{DD}=-15V$ $I_D=-1A$ $R_G=6\Omega$		13	23	ns
Turn-On Rise Time	t_r			13.5	24	
Turn-Off Delay Time	$t_{d(off)}$			42	68	
Turn-Off Fall Time	t_f			25	40	

电参数曲线图 / Electrical Characteristic Curve

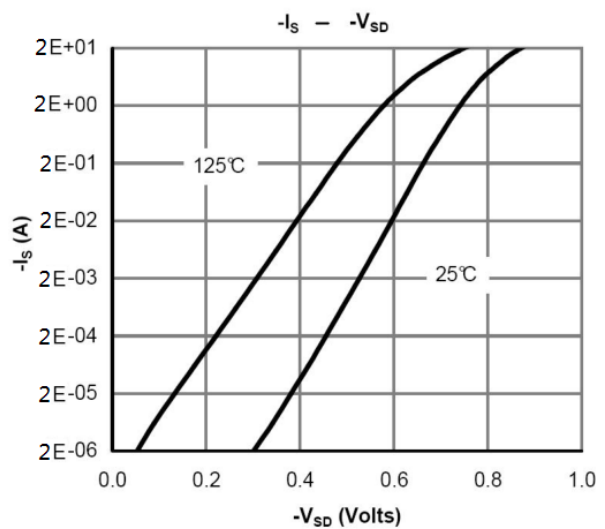
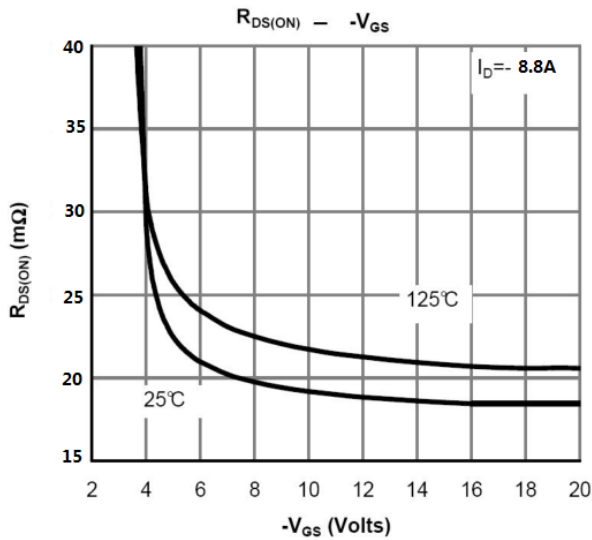
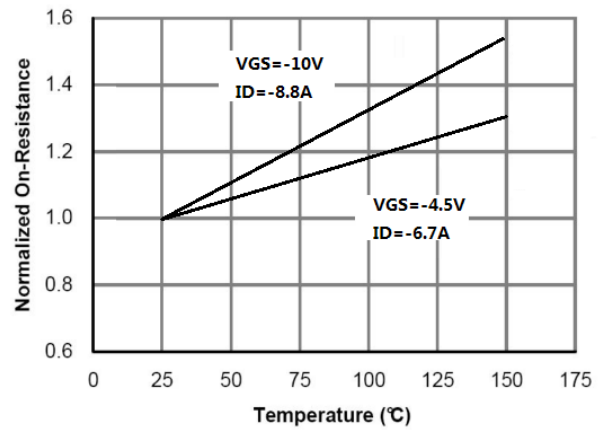
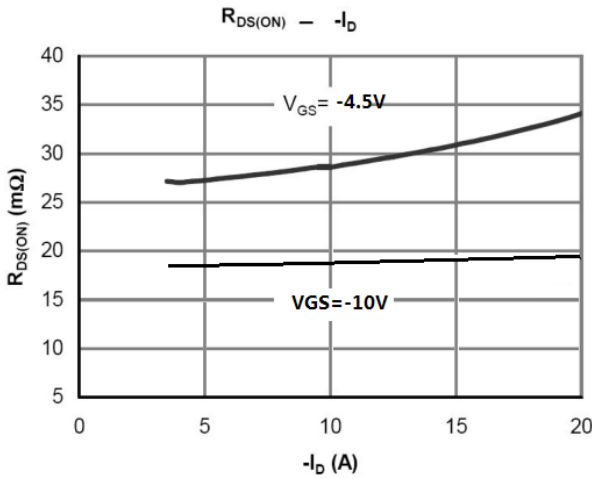
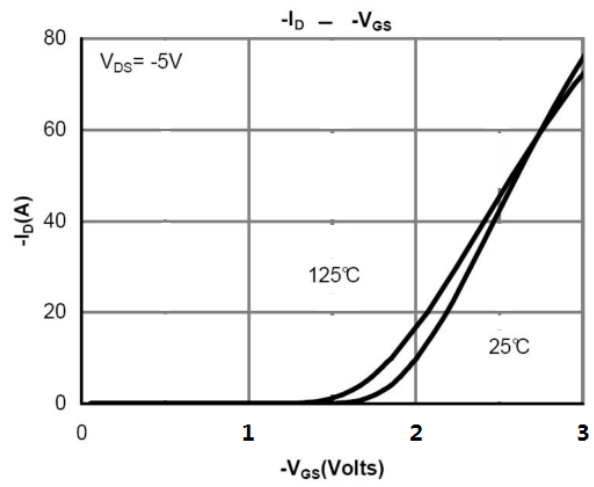
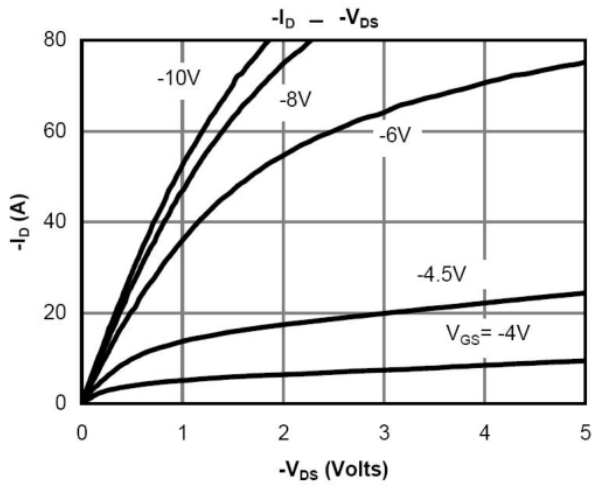

电参数曲线图 / Electrical Characteristic Curve

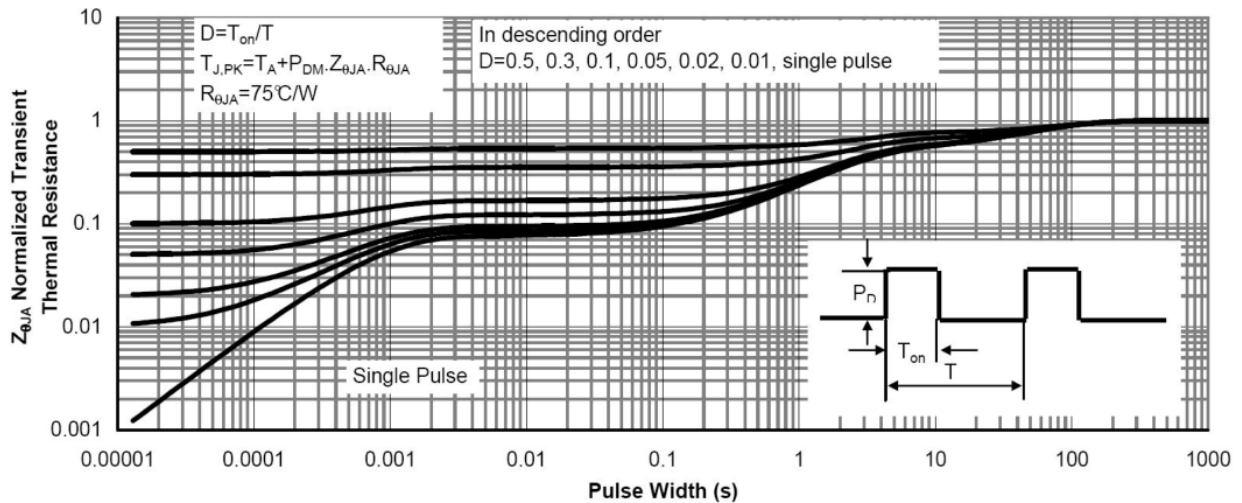
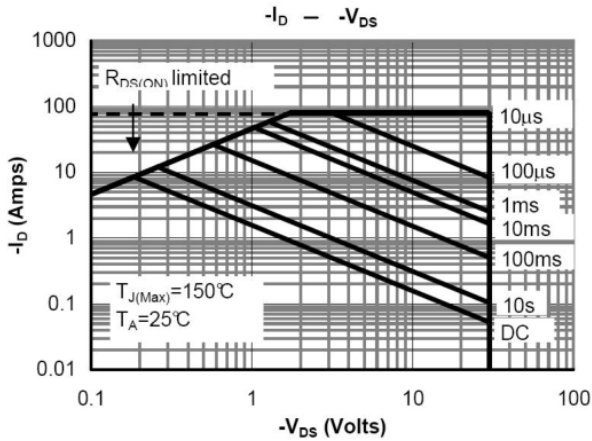
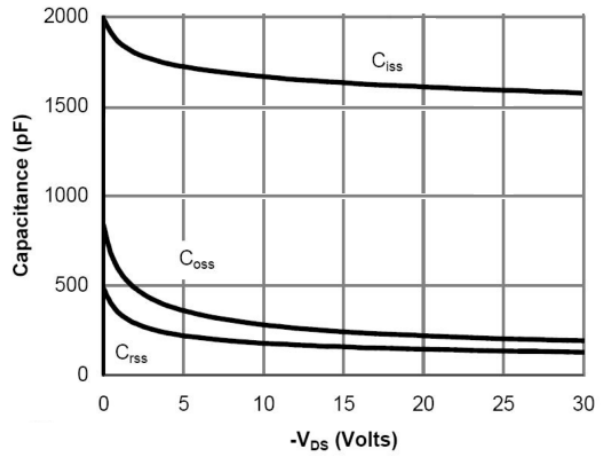
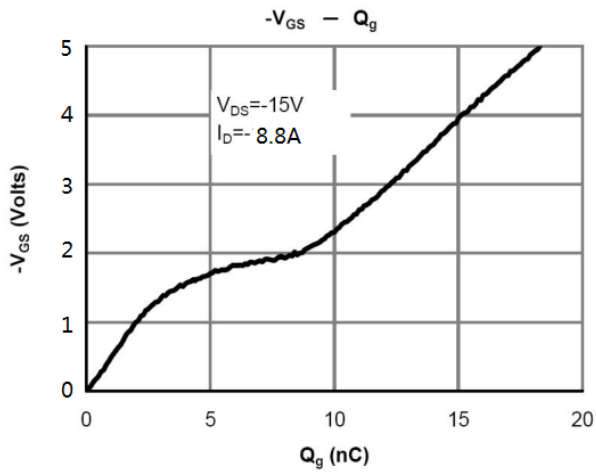

外形尺寸图 / Package Dimensions

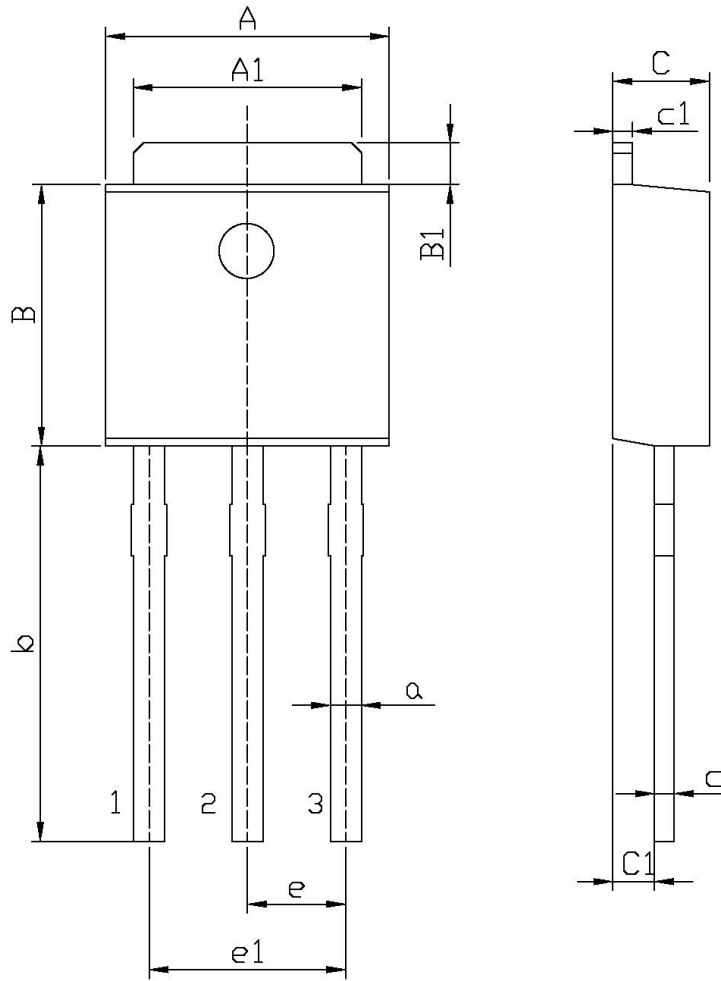

单位: mm

Symbol	Dimensions In Millimeters		Symbol	Dimensions In Millimeters	
	Min	Max		Min	Max
A	6.45	6.75	a	0.50	0.70
A1	5.10	5.50	b	9.00	9.40
B	5.95	6.25	c	0.45	0.55
B1	0.95	1.25	c1	0.45	0.55
C	2.20	2.40	e	2.24	2.34
C1	0.95	1.15	e1	4.43	4.73

TO-251

印章说明 / Marking Instructions

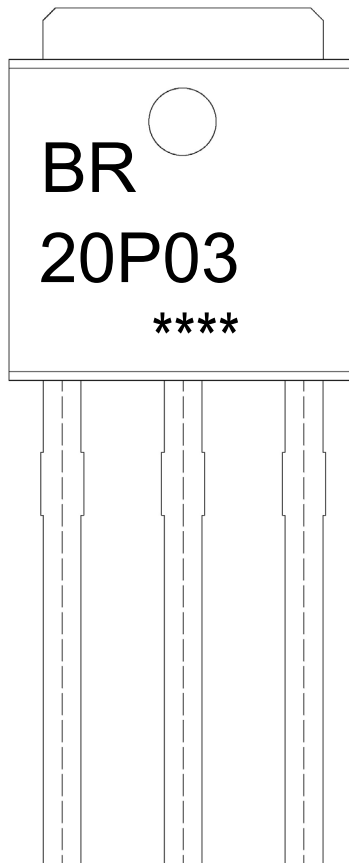

说明：

BR： 为公司代码

20P03： 为型号代码

****： 为生产批号代码，随生产批号变化。

Note:

BR: Company Code

20P03: Product Type Code.

****: Lot No. Code, code change with Lot No.

波峰焊温度曲线图(无铅) / Temperature Profile for Dip Soldering(Pb-Free)

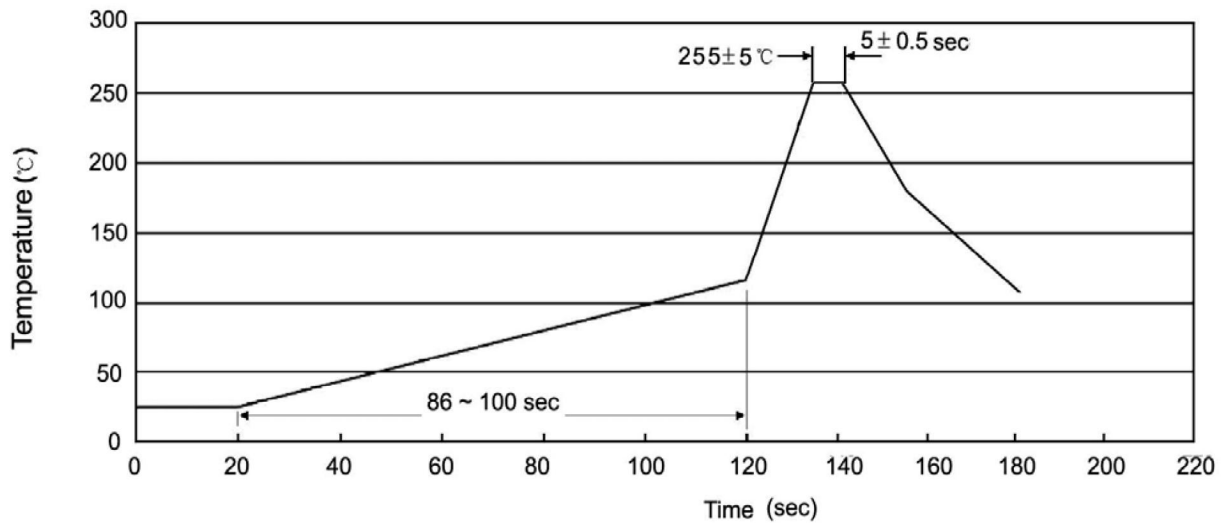

说明：

- 1、预热温度 25 ~ 150°C，时间 60 ~ 90sec；
- 2、峰值温度 255±5°C，时间持续为 5±0.5sec；
- 3、焊接制程冷却速度为 2 ~ 10°C/sec.

Note:

- 1.Preheating:25~150°C, Time:60~90sec.
- 2.Peak Temp.:255±5°C, Duration:5±0.5sec.
3. Cooling Speed: 2~10°C/sec.

耐焊接热试验条件 / Resistance to Soldering Heat Test Conditions

温度：270±5°C

时间：10±1 sec.

Temp.:270±5°C

Time:10±1 sec

包装规格 / Packaging SPEC.

散件包装 / REEL

Package Type 封装形式	Units 包装数量					Dimension 包装尺寸 (unit: mm ³)		
	Units/Reel 只/卷盘	Reels/Inner Box 卷盘/盒	Units/Inner Box 只/盒	Inner Boxes/Outer Box 盒/箱	Units/Outer Box 只/箱	Reel	Inner Box 盒	Outer Box 箱
TO-251	1,000	10	10,000	5	50,000	135×190	237×172×102	560×245×195

套管包装 / TUBE

Package Type 封装形式	Units 包装数量					Dimension 包装尺寸 (unit: mm ³)		
	Units/Tube 只/套管	Tubes/Inner Box 套管/盒	Units/Inner Box 只/盒	Inner Boxes/Outer Box 盒/箱	Units/Outer Box 只/箱	Tube 套管	Inner Box 盒	Outer Box 箱
TO-251/252	75	48	3,600	5	18,000	526×20.5×5.25	555×164×50	575×290×180

使用说明 / Notices