

BRMUR1060AC

Rev.G Jan.-2019

描述 / Descriptions

TO-220AC 塑封封装 超快恢复二极管。

Ultrafast Recovery Diode in a TO-220AC Plastic Package.

特征 / Features

采用硅外延工艺生产的超快恢复二极管，具有较低的反向漏电和高可靠性。

Silicon epitaxial process to produce ultrafast recovery diode with low reverse leakage current and high reliability.

用途 / Applications

用于高频、高压、大电流整流二极管，续流二极管。

For high frequency, high voltage, high current rectifier diode, freewheeling diode.

内部等效电路 / Equivalent Circuit

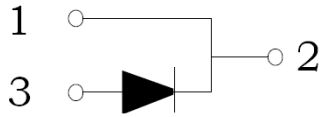

引脚排列 / Pinning

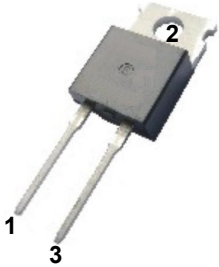

PIN1、2 : Cathode

PIN 3 : Anode

放大及印章代码 / h_{FE} Classifications & Marking

见印章说明。 See Marking Instructions

极限参数 / Absolute Maximum Ratings(Ta=25°C)

参数 Parameter	符号 Symbol	数值 Rating	单位 Unit
Peak Repetitive Reverse Voltage	V_{RRM}	600	V
RMS Voltage	V_{RMS}	420	V
DC Blocking Voltage	V_{DC}	600	V
Average Forward Current	I_F	1×10	A
Peak forward surge current	I_{FSM}	100	A
Typical Thermal Resistance Junction to Case	$R_{\theta Jc}$	1.5	°C/W
Junction Temperature Range	T_j	150	°C
Storage Temperature Range	T_{stg}	-55~150	°C

电性能参数 / Electrical Characteristics(Ta=25°C)

参数 Parameter	符号 Symbol	测试条件 Test Conditions	最小值 Min	典型值 Typ	最大值 Max	单位 Unit
Reverse Voltage	V_R	$I_R=1mA$	600			V
Forward Voltage	V_F	$I_F=2.0A$ $T_C=25^\circ C$		1.0	1.2	V
		$I_F=2.0A$ $T_C=150^\circ C$		0.73	1.0	
		$I_F=10A$ $T_C=25^\circ C$		1.3	1.5	
		$I_F=10A$ $T_C=150^\circ C$		1.1	1.2	
Instantaneous Reverse Current(Note1)	I_R	$V_R=600V$ $T_a=25^\circ C$			10	μA
		$V_R=480V$ $T_a=150^\circ C$			100	
		$V_R=600V$ $T_a=150^\circ C$			500	
Reverse Recovery Time	t_{rr}	$I_F=0.5A$ $I_R=1.0A$ $I_{RR}=0.25A$			50	ns

注/Notes:

1. 使用极短的测试时间,以尽量减少自热效应。/Short duration pulse test used to minimize self-heating effect.
2. 除非特别注明,数值为一个芯片的参数。/ Unless otherwise noted, values for the parameters of a single chip

电参数曲线图 / Electrical Characteristic Curve

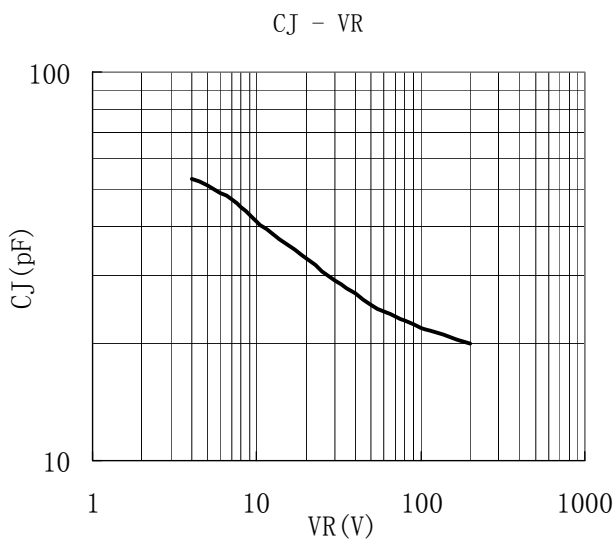
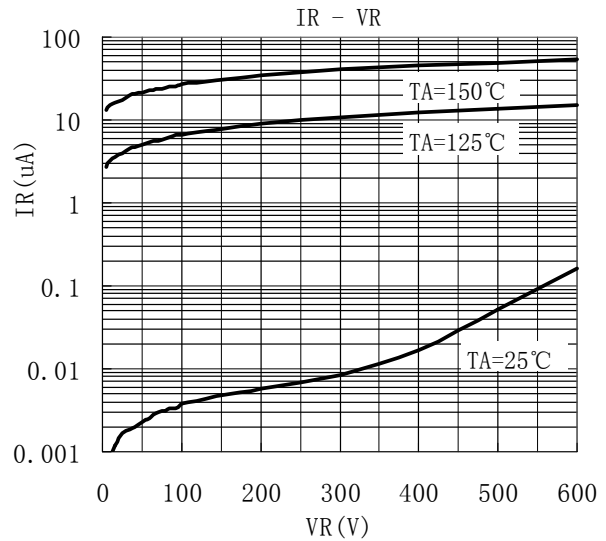
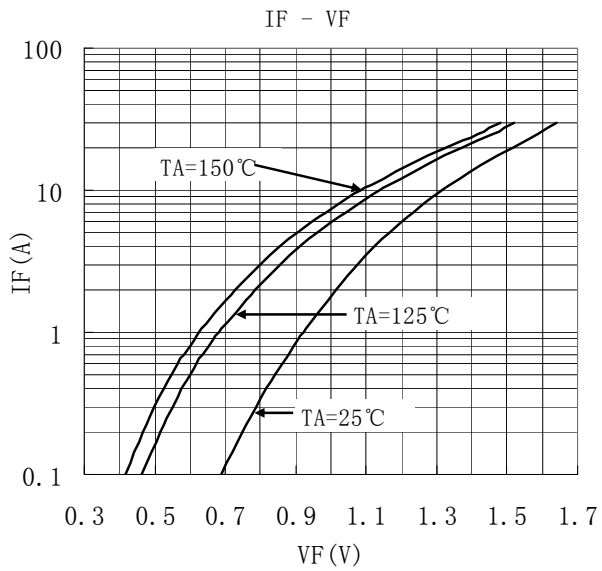
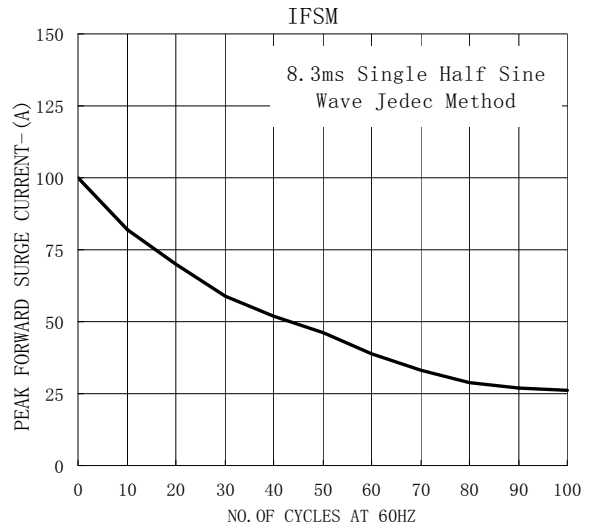
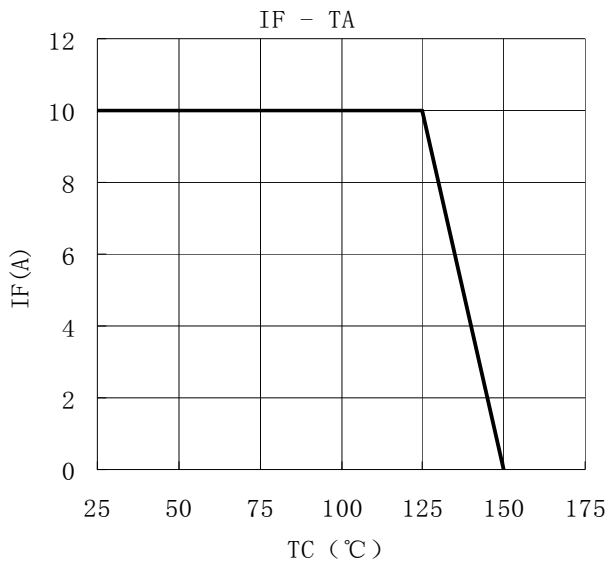

外形尺寸图 / Package Dimensions

TO-220AC

Unit:mm

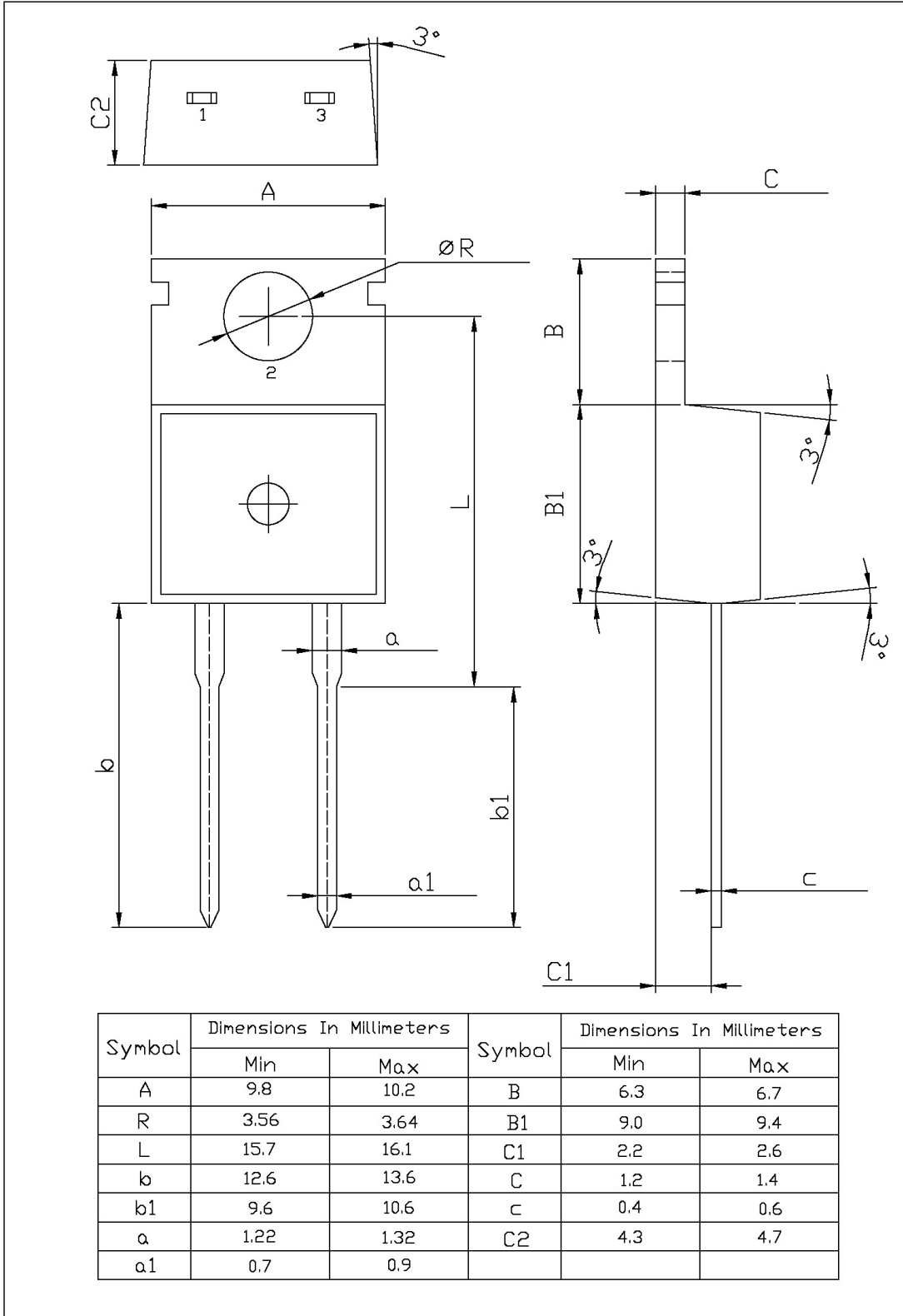

印章说明 / Marking Instructions

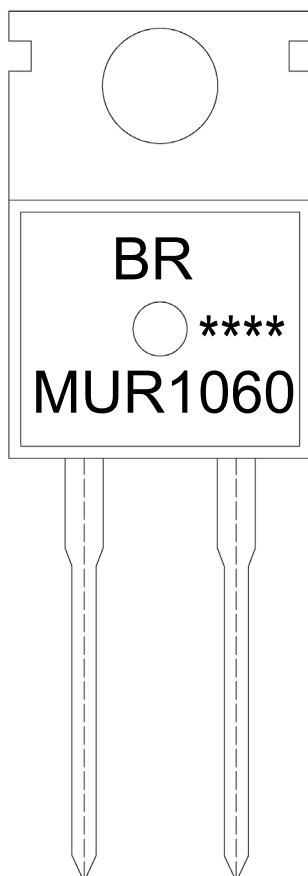

说明：

BR： 为公司代码

MUR1060： 为产品型号

****： 为生产批号代码，随生产批号变化。

Note:

BR: Company Code

MUR1060: Product Type.

****: Lot No. Code, code change with Lot No.

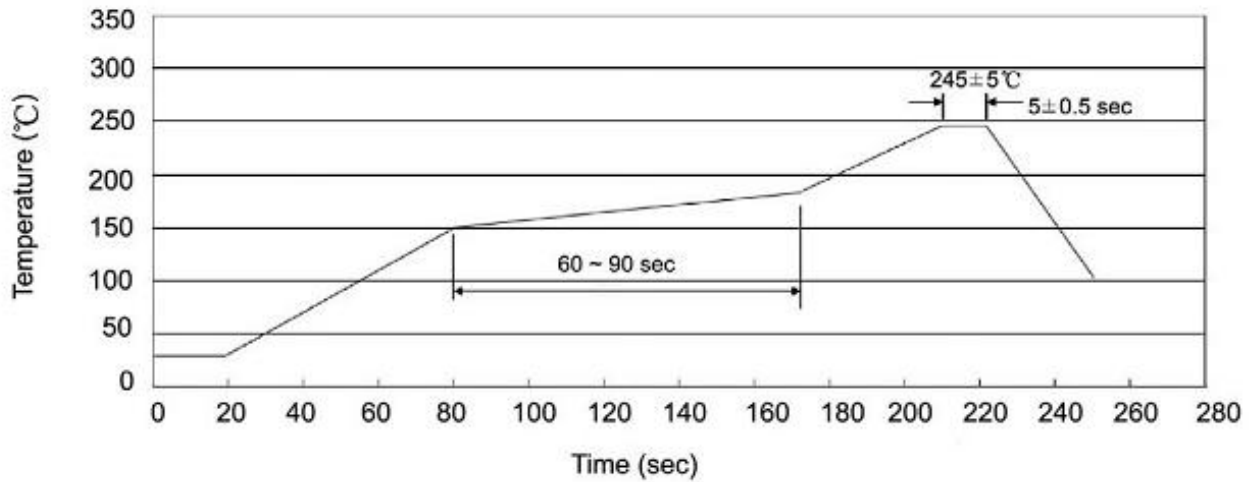
波峰焊温度曲线图(无铅) / Temperature Profile for Dip Soldering(Pb-Free)

说明：

- 1、预热温度 150~180°C，时间 60~90sec；
- 2、峰值温度 255±5°C，时间持续为 5±0.5sec；
- 3、焊接制程冷却速度为 2~10°C/sec.

Note:

- 1.Preheating:150~180°C, Time:60~90sec.
- 2.Peak Temp.:255±5°C, Duration:5±0.5sec.
3. Cooling Speed: 2~10°C/sec.

耐焊接热试验条件 / Resistance to Soldering Heat Test Conditions

温度：270±5°C

时间：10±1 sec.

Temp.:270±5°C

Time:10±1 sec

包装规格 / Packaging SPEC.

散件包装 / BULK

Package Type 封装形式	Units 包装数量					Dimension 包装尺寸 (unit: mm ³)		
	Units/Bag 只/袋	Bags/Inner Box 袋/盒	Units/Inner Box 只/盒	Inner Boxes/Outer Box 盒/箱	Units/Outer Box 只/箱	Bag 袋	Inner Box 盒	Outer Box 箱
TO-220/F/AC	200	10	2,000	5	10,000	135×190	237×172×102	560×245×195

套管包装 / TUBE

Package Type 封装形式	Units 包装数量					Dimension 包装尺寸 (unit: mm ³)		
	Units/Tube 只/套管	Tubes/Inner Box 套管/盒	Units/Inner Box 只/盒	Inner Boxes/Outer Box 盒/箱	Units/Outer Box 只/箱	Tube 套管	Inner Box 盒	Outer Box 箱
TO-220/F/AC	50	20	1,000	5	5,000	532×31.4×5.5	555×164×50	575×290×180

使用说明 / Notices