

# MBRD1045

Rev.G Dec.-2023

## 描述 / Descriptions

TO-252 塑封封装 肖特基二极管。  
Schottky Barrier Diode in a TO-252 Plastic Package.

## 特征 / Features

损耗低，效率高，无卤产品。  
Low power loss, high efficiency, HF Product.

## 用途 / Applications

用于高频、低压、大电流整流二极管，续流二极管，保护二极管。  
For use in low voltage, high frequency inverters, free wheeling, and polarity protection applications.

## 内部等效电路 / Equivalent Circuit

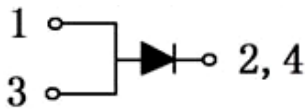

## 引脚排列 / Pinning

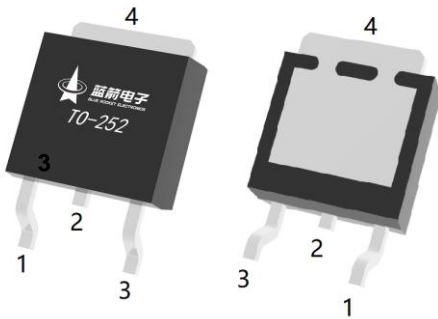

PIN1 : Anode

PIN 2,4 : Cathode

PIN 3 : Anode

## 印章代码 / Marking

见印章说明。  
See Marking Instructions.

**极限参数 / Absolute Maximum Ratings(Ta=25°C)**

参数 Parameter	符号 Symbol	数值 Rating	单位 Unit
Peak Repetitive Reverse Voltage Working Peak Reverse Voltage	$V_{RRM}$ $V_{RWM}$	45	V
Reverse Voltage	$V_R$	45	V
Average Rectified Forward Current	$I_{F(AV)}$	10	A
Non Repetitive Peak Surge Current	$I_{FSM}$	100	A
Junction Temperature Range	$T_j$	150	°C
Storage Temperature Range	$T_{stg}$	-65~150	°C

**电性能参数 / Electrical Characteristics(Ta=25°C)**

参数 Parameter	符号 Symbol	测试条件 Test Conditions	最小值 Min	典型值 Typ	最大值 Max	单位 Unit
Reverse Voltage	$V_R$	$I_R = 1mA$	45			V
Peak Forward Voltage	$V_{FM}$	$I_F = 5.0A(T_C = 25°C)$		0.41	0.49	V
		$I_F = 5.0A(T_C = 125°C)$		0.37	0.41	V
		$I_F = 10A(T_C = 25°C)$		0.47	0.55	V
Instantaneous Reverse Current	$I_{RM}$	$V_R = 40V(T_C = 25°C)$			0.5	mA
		$V_R = 40V(T_C = 125°C)$			50	mA
Voltage Rate of Change	dv/dt				10000	V/μs

**电参数曲线图 / Electrical Characteristic Curve**

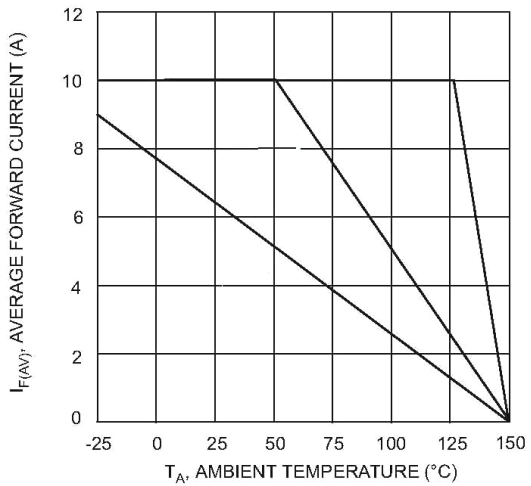
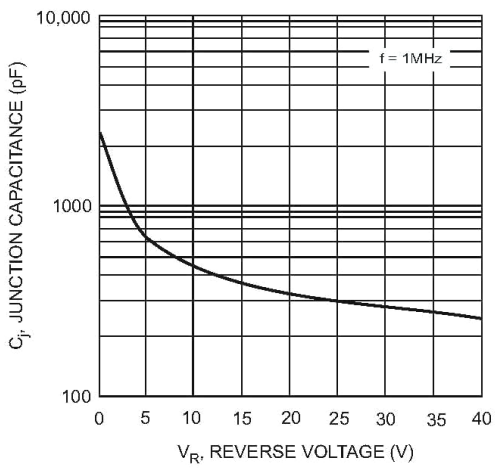
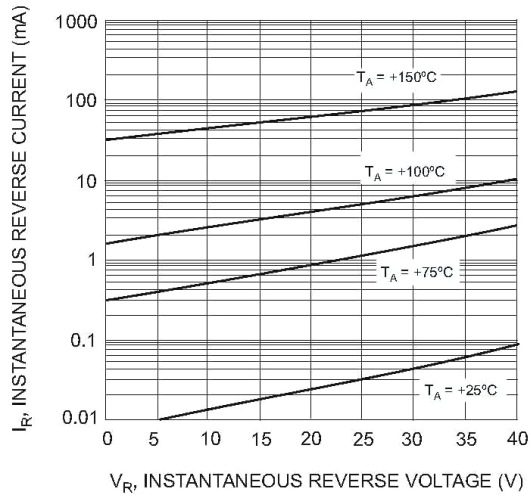
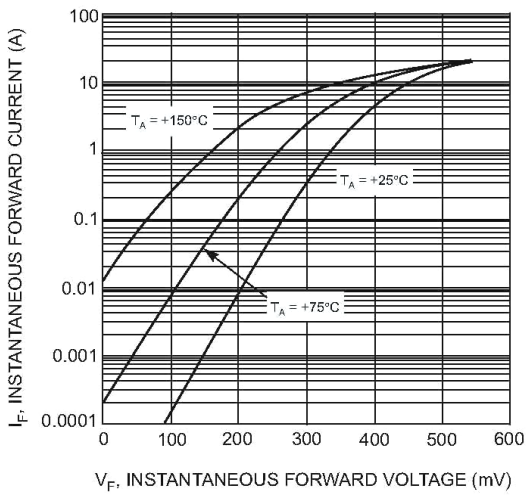

**外形尺寸图 / Package Dimensions**

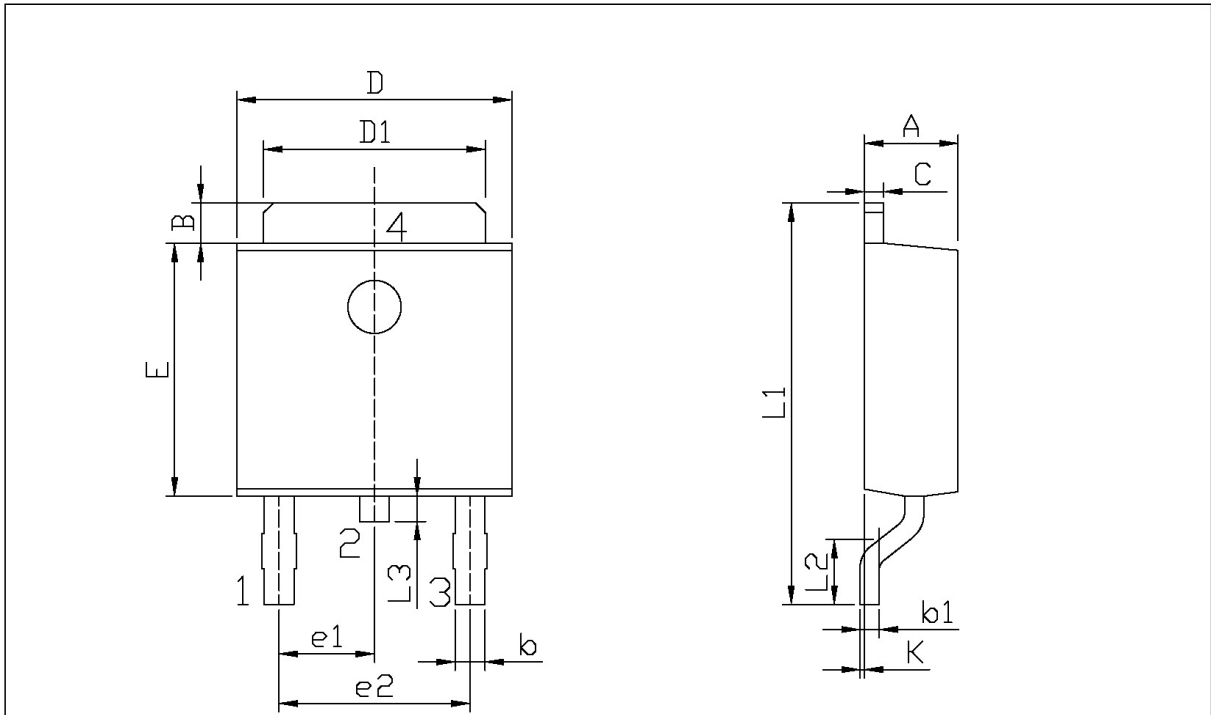

单位: mm

Symbol	Dimensions In Millimeters		Symbol	Dimensions In Millimeters	
	Min	Max		Min	Max
A	2.20	2.40	E	5.95	6.25
B	0.95	1.25	e1	2.24	2.34
b	0.50	0.90	e2	4.43	4.73
b1	0.45	0.55	L1	9.45	9.95
C	0.45	0.55	L2	1.25	1.75
D	6.45	6.75	L3	0.60	0.90
D1	5.10	5.50	K	0.00	0.10

TO-252

**印章说明 / Marking Instructions**

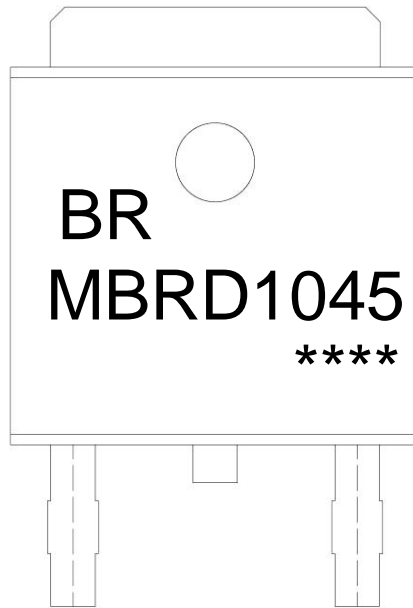

说明：

BR： 为公司代码

MBRD1045： 为型号代码

\*\*\*\*： 为生产批号代码，随生产批号变化

Note:

BR: Company Code

MBRD1045： Product Type Code

\*\*\*\*: Lot No. Code, code change with Lot No

**回流焊温度曲线图(无铅) / Temperature Profile for IR Reflow Soldering(Pb-Free)**

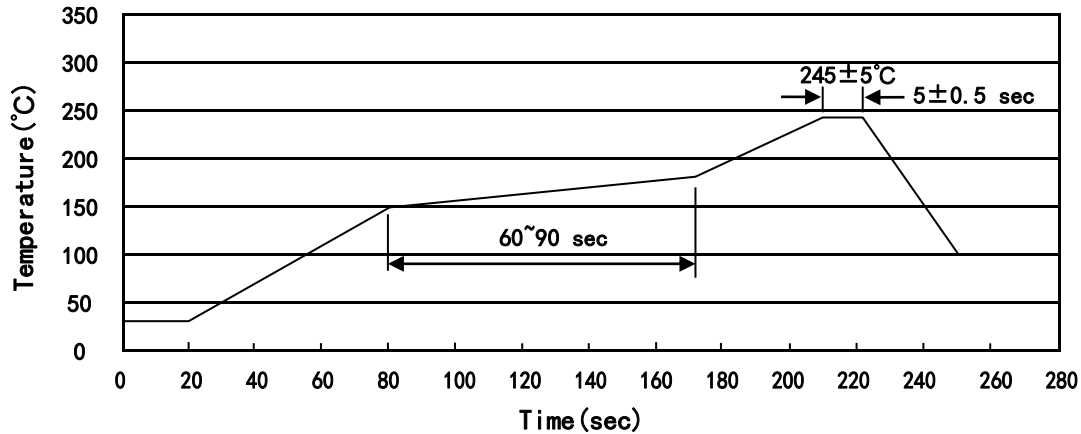

说明：

- 1、预热温度 150~180°C，时间 60~90sec;
- 2、峰值温度 245±5°C，时间持续为 5±0.5sec;
- 3、焊接制程冷却速度为 2~10°C/sec.

Note:

- 1.Preheating:150~180°C, Time:60~90sec.
- 2.Peak Temp.:245±5°C, Duration:5±0.5sec.
3. Cooling Speed: 2~10°C/sec.

**耐焊接热试验条件 / Resistance to Soldering Heat Test Conditions**

温度：260±5°C      时间：10±1 sec.      Temp.:260±5°C      Time:10±1 sec

**包装规格 / Packaging SPEC.**

卷盘包装 / REEL

Package Type 封装形式	Units 包装数量					Dimension 包装尺寸 (unit: mm <sup>3</sup> )		
	Units/Reel 只/卷盘	Reels/Inner Box 卷盘/盒	Units/Inner Box 只/盒	Inner Boxes/Outer Box 盒/箱	Units/Outer Box 只/箱	Reel	Inner Box 盒	Outer Box 箱
TO-252	2,500	2	5,000	6	30,000	13" x16	360x360x50	380x335x366

套管包装 / TUBE

Package Type 封装形式	Units 包装数量					Dimension 包装尺寸 (unit: mm <sup>3</sup> )		
	Units/Tube 只/套管	Tubes/Inner Box 套管/盒	Units/Inner Box 只/盒	Inner Boxes/Outer Box 盒/箱	Units/Outer Box 只/箱	Tube 套管	Inner Box 盒	Outer Box 箱
TO-251/252	75	48	3,600	5	18,000	526x20.5x5.25	555x164x50	575x290x180

**使用说明 / Notices**