

# MBRF10200

Rev.E Mar.-2016



## 描述 / Descriptions

TO-220FL 塑封封装 肖特基二极管。  
Schottky Diode in a TO-220FL Plastic Package.

## 特征 / Features

损耗低，效率高。  
Low power loss, high efficiency.

## 用途 / Applications

用于高频、低压、大电流整流二极管、续流二极管、保护二极管。  
For use in low voltage, high frequency inverters, free wheeling, and polarity protection applications.

## 内部等效电路 / Equivalent Circuit

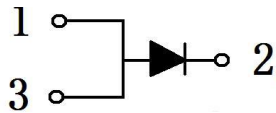

## 引脚排列 / Pinning

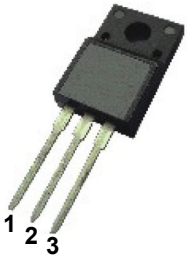

PIN1 : Cathode      PIN 2 : Anode      PIN 3 : Cathode

## 放大及印章代码 / $h_{FE}$ Classifications & Marking

见印章说明。 See Marking Instructions.

**极限参数 / Absolute Maximum Ratings(Ta=25°C)**

参数 Parameter	符号 Symbol	数值 Rating	单位 Unit
Peak Repetitive Reverse Voltage	$V_{RRM}$	200	V
Average Forward Rectified Current	$I_{F(AV)}$	10	A
Peak Repetitive Forward Current	$I_{FRM}$	10	A
Peak Forward Surge Current	$I_{FSM}$	150	A
Peak Repetitive Reverse Current	$I_{RRM}$	0.5	A
Thermal Resistance Junction to Case	$R_{\theta Jc}$	2.8	°C/W
Junction and Storage Temperature Range	$T_j, T_{stg}$	-55~150	°C

**电性能参数 / Electrical Characteristics(Ta=25°C)**

参数 Parameter	符号 Symbol	测试条件 Test Conditions	数值 Rating			单位 Unit
			最小值 Min	典型值 Typ	最大值 Max	
Reverse Voltage	$V_R$		200			V
Forward Voltage	$V_F$	$I_F=5A$			0.99	V
		$I_F=5A(T_c=125^\circ C)$			0.87	V
Instantaneous Reverse Current	$I_R$	$V_R=200V$			0.15	mA
		$V_R=200V(T_c=125^\circ C)$			150	mA
Voltage Rate of Change	$dv/dt$				10000	V/ $\mu s$

**电参数曲线图 / Electrical Characteristic Curve**

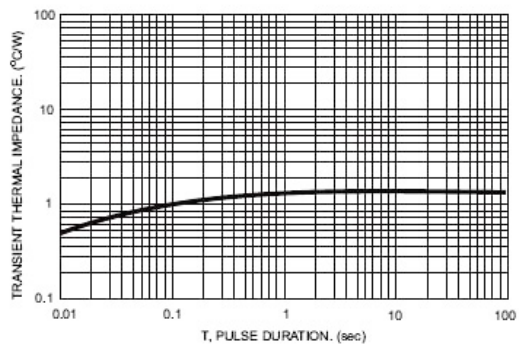
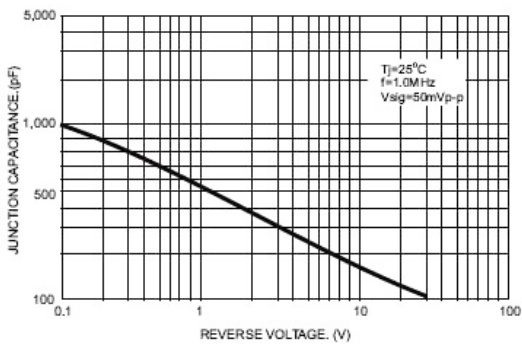
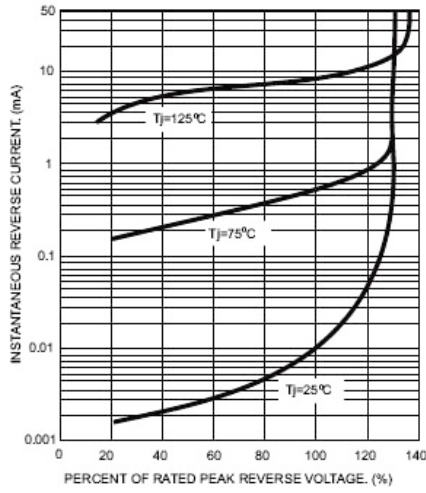
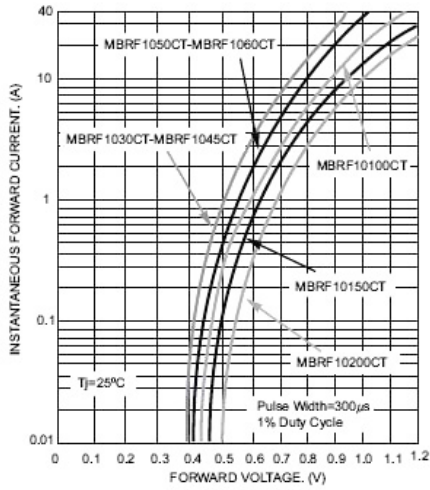
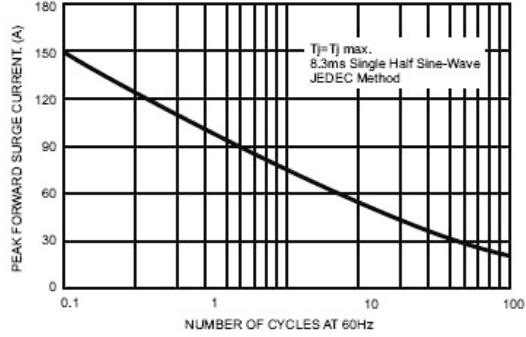
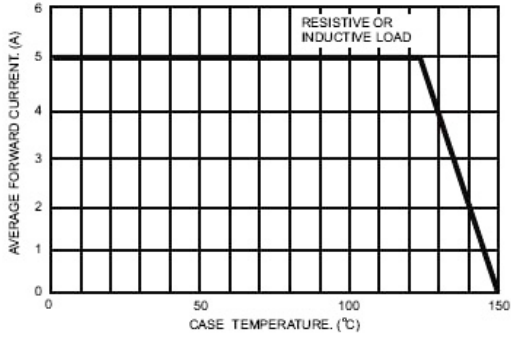

**外形尺寸图 / Package Dimensions**

TO-220FL

单位: mm

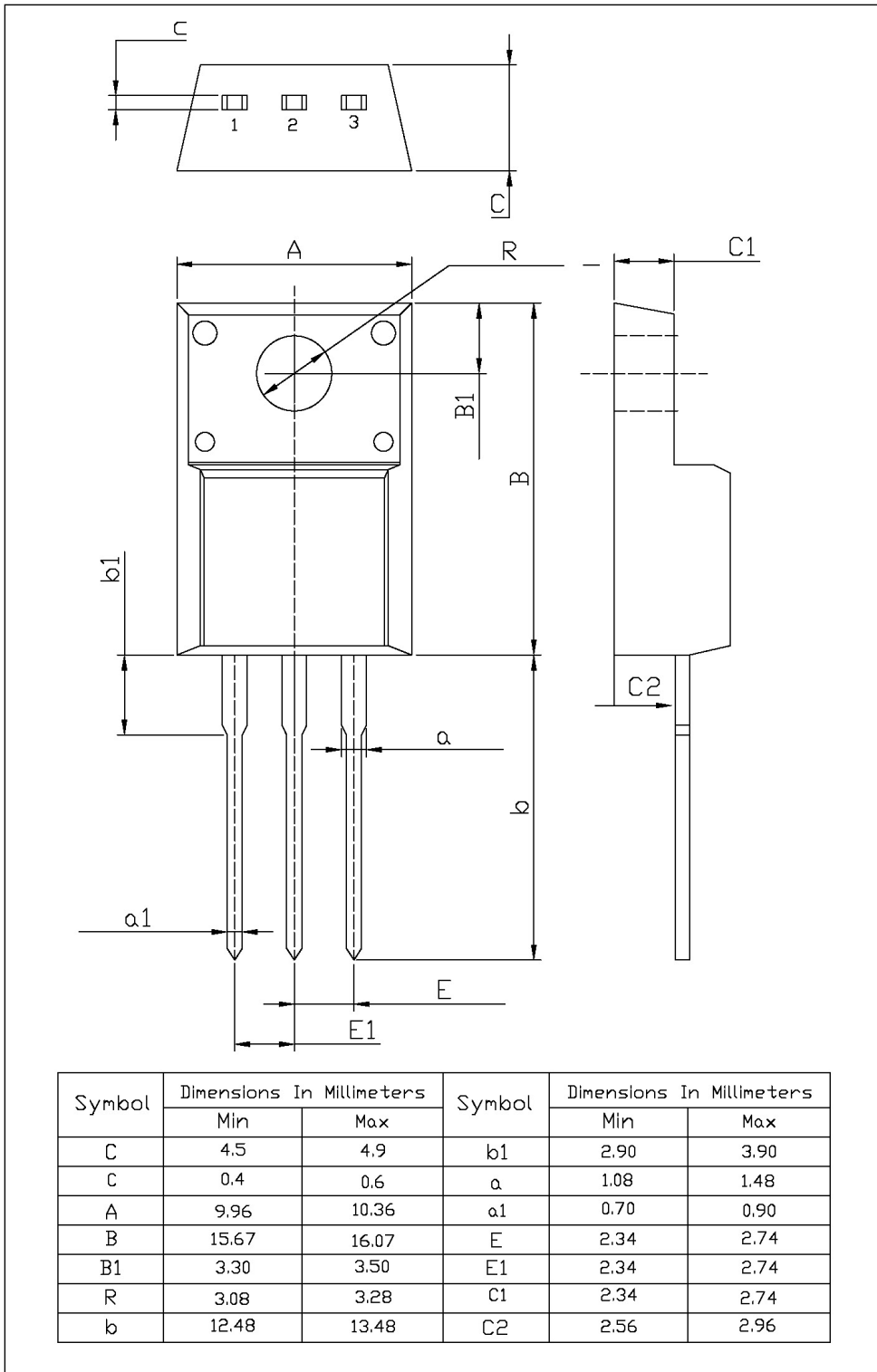

**印章说明 / Marking Instructions**

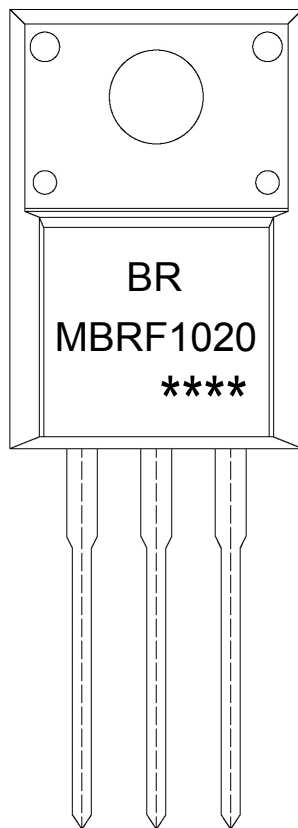

说明：

BR： 为公司代码

MBRF10200： 为产品型号

\*\*\*\*： 为生产批号代码，随生产批号变化。

Note:

BR: Company Code

MBRF10200: Product Type

\*\*\*\*: Lot No. Code, code change with Lot No.

**波峰焊温度曲线图(无铅) / Temperature Profile for Dip Soldering(Pb-Free)**

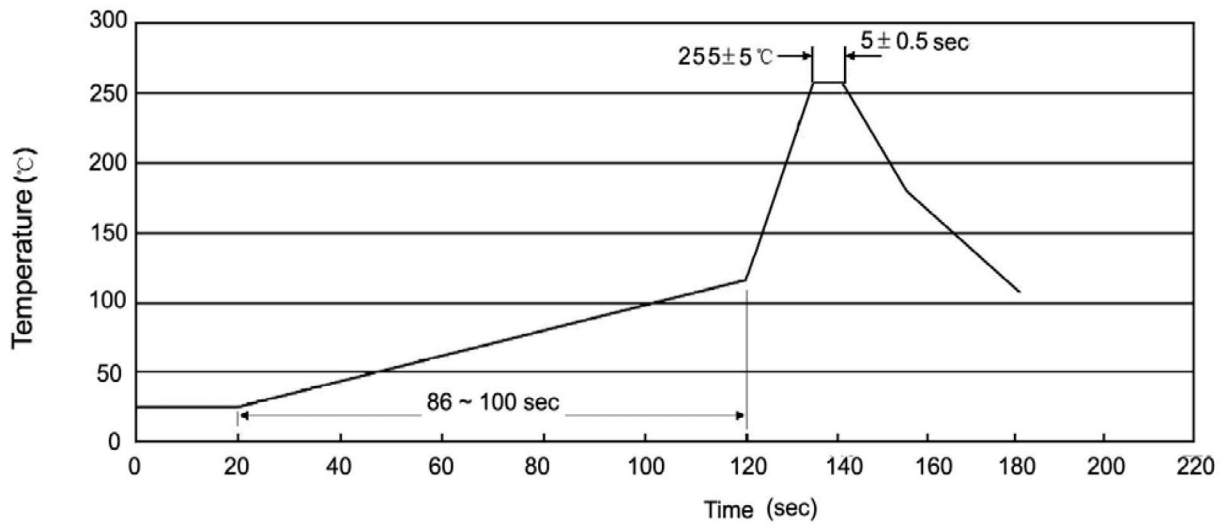

说明：

- 1、预热温度 25 ~ 150°C，时间 60 ~ 90sec;
- 2、峰值温度 255±5°C，时间持续为 5±0.5sec;
- 3、焊接制程冷却速度为 2 ~ 10°C/sec.

Note:

- 1.Preheating:25~150°C, Time:60~90sec.
- 2.Peak Temp.:255±5°C, Duration:5±0.5sec.
3. Cooling Speed: 2~10°C/sec.

**耐焊接热试验条件 / Resistance to Soldering Heat Test Conditions**

温度：270±5°C

时间：10±1 sec.

Temp.:270±5°C

Time:10±1 sec

**包装规格 / Packaging SPEC.**

套管包装 / TUBE

Package Type 封装形式	Units 包装数量					Dimension 包装尺寸 (unit: mm <sup>3</sup> )		
	Units/Tube 只/套管	Tubes/Inner Box 套管/盒	Units/Inner Box 只/盒	Inner Boxes/Outer Box 盒/箱	Units/Outer Box 只/箱	Tube 套管	Inner Box 盒	Outer Box 箱
TO-220FL	50	20	1,000	5	5,000	532×33×7.0	555×164×50	575×290×180

**使用说明 / Notices**