

SSL56B~SSL510B

Rev. A Feb.-2019

描述 / Descriptions

表面贴装肖特基整流二极管，反向电压：60V~100V，正向电流：5.0A，SMB封装。

Surface Mount Schottky Barrier Rectifiers, Reverse Voltage : 60 to 100V, Forward Current: 5.0A, SMB package.

特征 / Features

低功耗，高效率，高正向浪涌电流能力，适用表面贴装。无卤产品。

Low power loss, High efficiency, High forward surge current capability, For surface mounted applications. HF product.

用途 / Applications

一般用途。

General purpose.

内部等效电路 / Equivalent Circuit



引脚排列 / Pinning

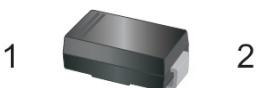

PIN	DESCRIPTION
1	Cathode
2	Anode

The recommended mounting pad size

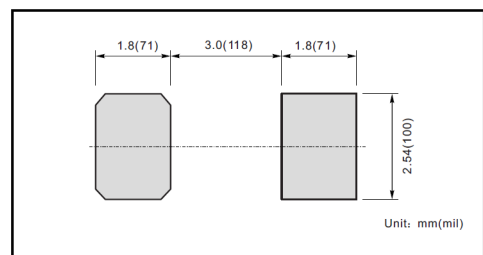

印章代码 / Marking

见印章说明。See Marking Instructions.

极限参数 / Absolute Maximum Ratings(Ta=25°C)

参数 Parameter	符号 Symbol	数值 Rating		单位 Unit
		SSL56B	SSL510B	
Maximum Repetitive Peak Reverse Voltage	V_{RRM}	60	100	V
Maximum RMS voltage	V_{RMS}	42	70	V
Maximum DC Blocking Voltage	V_{DC}	60	100	V
Maximum Average Forward Rectified Current	$I_{F(AV)}$	5.0		A
Peak Forward Surge Current 8.3 ms Single Half Sine Wave Superimposed on Rated Load (JEDEC Method)	I_{FSM}	150		A
Typical Junction Capacitance ⁽¹⁾	C_j	600		pF
Typical Thermal Resistance ⁽²⁾	$R_{\theta JA}$	45		°C/W
Operating and Storage Temperature Range	T_j, T_{stg}	-55~+150		°C

Note:

- 1) Measured at 1 MHz and applied reverse voltage of 4 V D.C
- 2) P.C.B. mounted with 2.0" X 2.0" (5 X 5 cm) copper pad areas.

电性能参数 / Electrical Characteristics(Ta=25°C)

参数 Parameter	符号 Symbol	测试条件 Test Conditions	数值 Rating		单位 Unit
			SSL56B	SSL510B	
Maximum Instantaneous Forward Voltage	V_F	$I_F=5.0A$	0.5	0.6	V
Maximum DC Reverse Current at Rated DC Reverse Voltage	I_R	$T_a=25^\circ C$	1.0		mA
		$T_a=100^\circ C$	50		mA

电参数曲线图 / Electrical Characteristic Curve

Fig.1 Forward Current Derating Curve

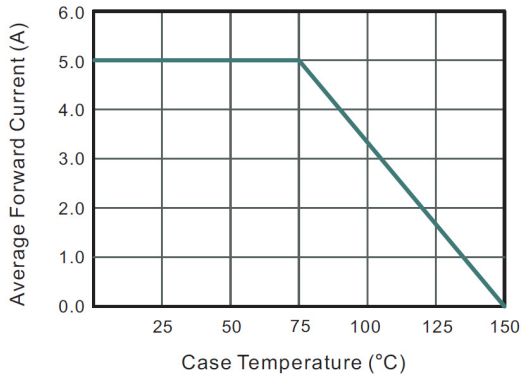

Fig.2 Typical Reverse Characteristics

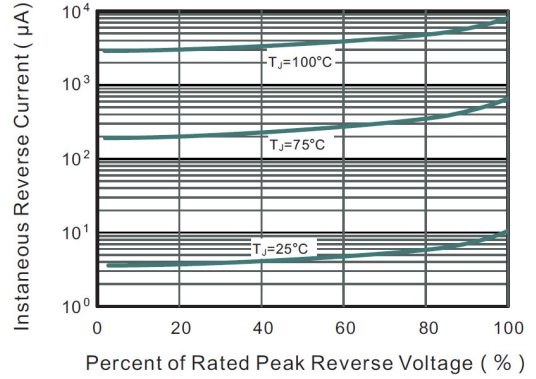

Fig.3 Typical Forward Characteristic

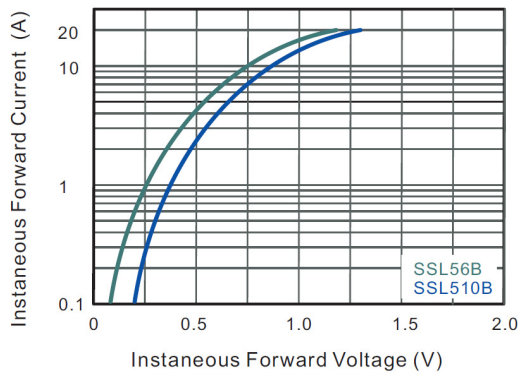

Fig.4 Typical Junction Capacitance

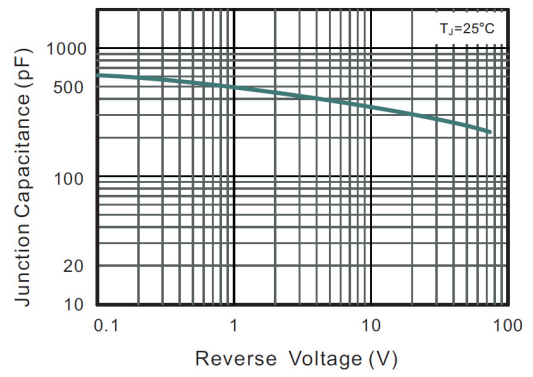

Fig.5 Maximum Non-Repetitive Peak Forward Surge Current

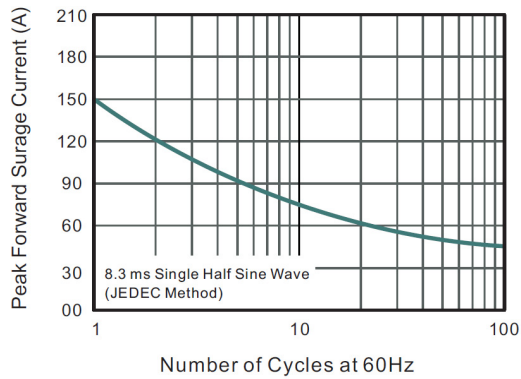
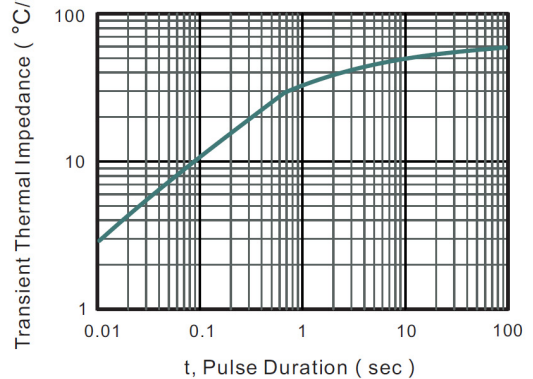
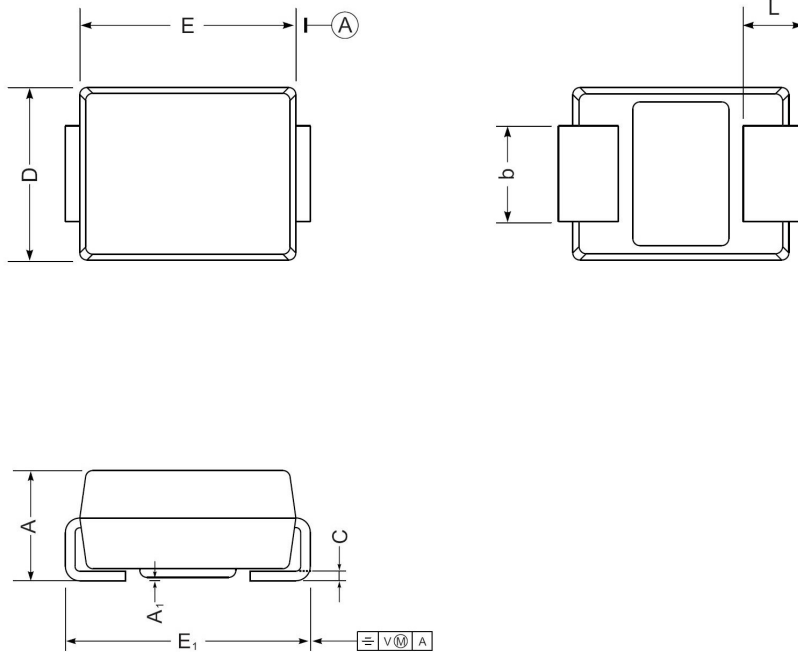

Fig.6- Typical Transient Thermal Impedance



外形尺寸图 / Package Dimensions

SMB



SMB mechanical data

UNIT		A	E	D	E ₁	A ₁	L	C	b
mm	max	2.44	4.70	3.94	5.59	0.20	1.5	0.305	2.2
	min	2.13	4.06	3.3	5.08	0.05	0.8	0.152	1.9
mil	max	96	185	155	220	7.9	59	12	87
	min	84	160	130	200	2.0	32	6	75

Marking

Type number	Marking code
SSL56B	SL56B
SSL510B	SL510B

印章说明 / Marking Instructions

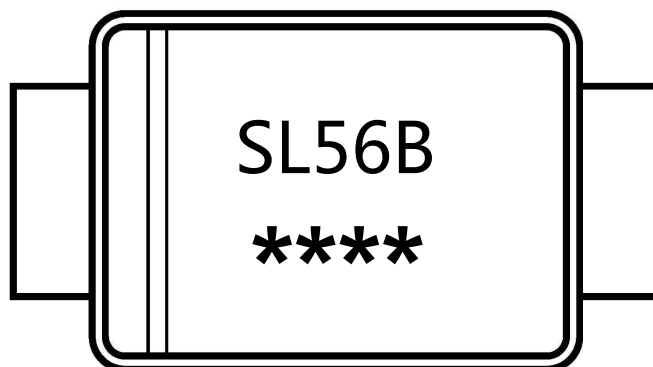

说明：

SL56B：为型号代码

****：为生产批号追溯码，第1个*为年月代码，后面3个*为当月小批号代码

Note:

SL56B：Product Type Code

****：Lot No. Code ,The 1st * means:YM Code ,The last 3 * means:little Lot No Code

回流焊温度曲线图(无铅) / Temperature Profile for IR Reflow Soldering(Pb-Free)

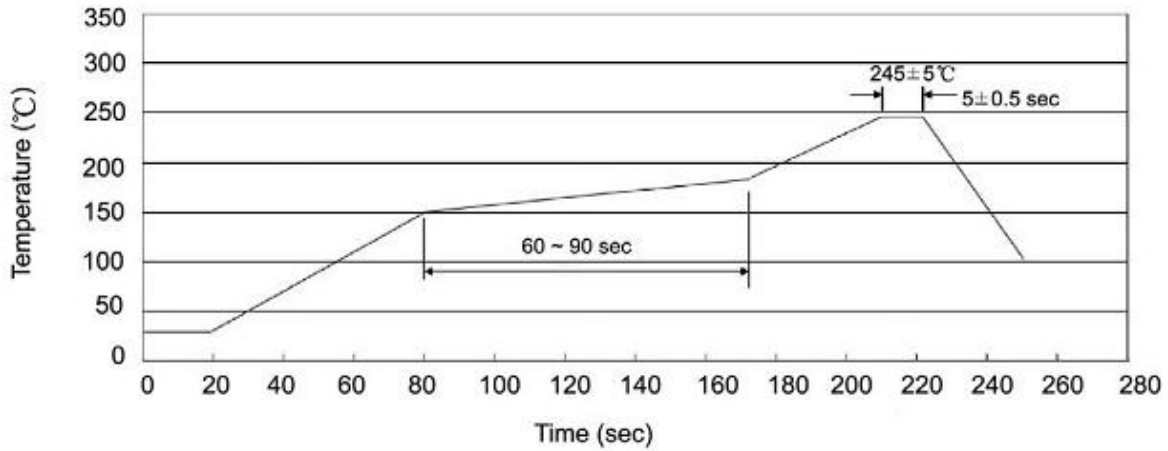

说明：

- 1、预热温度 150 ~ 180°C，时间 60 ~ 90sec；
- 2、峰值温度 245±5°C，时间持续为 5±0.5sec；
- 3、焊接制程冷却速度为 2 ~ 10°C/sec.

Note:

- 1.Preheating:150~180°C, Time:60~90sec.
- 2.Peak Temp.:245±5°C, Duration:5±0.5sec.
3. Cooling Speed: 2~10°C/sec.

耐焊接热试验条件 / Resistance to Soldering Heat Test Conditions

温度：260±5°C

时间：10±1 sec.

Temp.:260±5°C

Time:10±1 sec

包装规格 / Packaging SPEC.

卷盘包装 / REEL

Package Type 封装形式	Units 包装数量					Dimension 包装尺寸 (unit: mm ³)		
	Units/Reel 只/卷盘	Reels/Inner Box 卷盘/盒	Units/Inner Box 只/盒	Inner Boxes/Outer Box 盒/箱	Units/Outer Box 只/箱	Reel	Inner Box 盒	Outer Box 箱
SMB	3000	5	15000	5	75000	7" ×11	185X180X105	390X385X205

使用说明 / Notices